

WinCC V7.5 SP1 Architectures

In addition to the standard WinCC packages in European version, SIMATIC WinCC V7.5 SP1 and SIMATIC WinCC V7.5 SP1 ASIA will be available at following WinCC V7.5 SP1 Options



- WinCC/Server V7.5 SP1
- WinCC/Redundancy V7.5 SP1
- WinCC/Archive V7.5 SP1
- WinCC/UserArchives V7.5 SP1
- WinCC/WebNavigator V7.5 SP1
- WinCC/DataMonitor V7.5 SP1
- WinCC/Connectivity Pack V7.5 SP1
- WinCC/Connectivity Station V7.5 SP1
- WinCC/WebUX V7.5 SP1
- WinCC/ODK V7.5 SP1
- WinCC/IndustrialDataBridge V7.5 SP1
- WinCC/Audit V7.5 SP1
- WinCC/SESV7.5 SP1
- WinCC/Calendar Scheduler V7.5 SP1
- WinCC/Event Notifier V7.5 SP1
- WinCC/Performance Monitor V7.5 SP1
- WinCC/ProAgent V7.5 SP1
- SIMATIC Energy Manager V7.2
- SIMATIC InformationServer 2014 SP3 upd4
- SIMATIC ProcessHistorian 2014 SP3 upd4

About the delivery or compatibility test of the following options will be informed separately

- SIMATIC TeleControl

With the compatibility tool <http://www.siemens.com/kompatool> you could check the compatibility of the products.

WinCC V7.5 SP1 – Overview



Standardfeatures

WinCC V7.5 SP1 – basic package

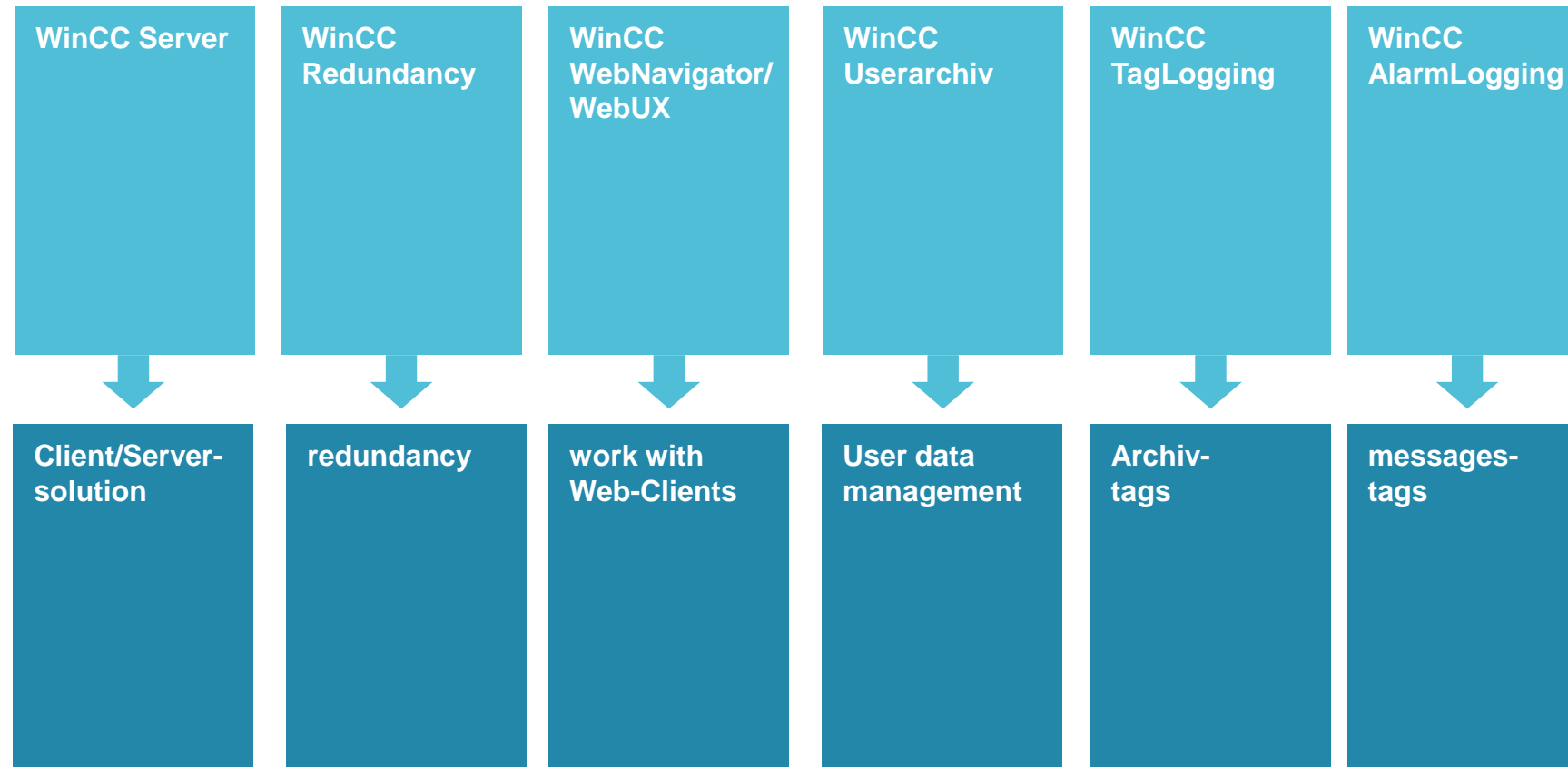

Options / PM Add on

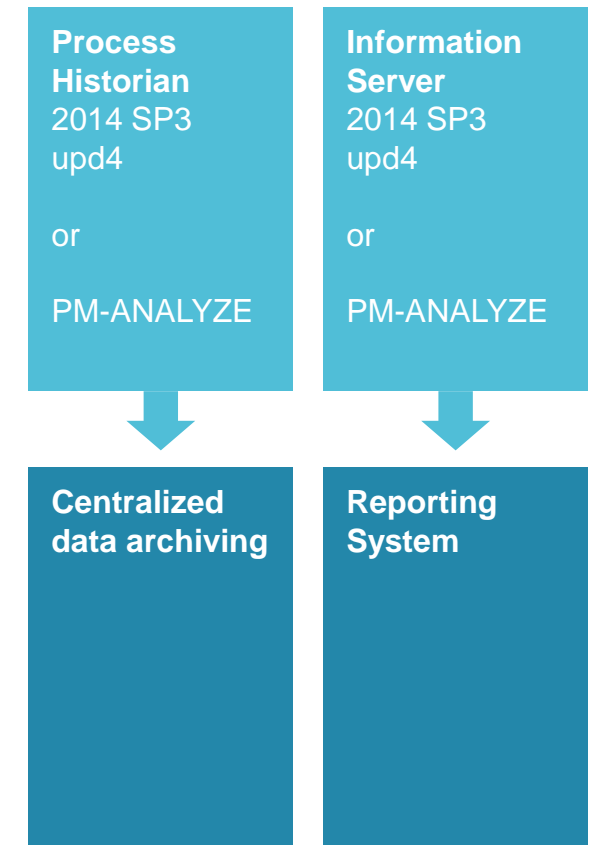

SIMATIC WinCC V7.5 SP1 / RT Professional

WinCC Premium Add-ons for Process Management



The delivery and / or compatibility test of the following PM add-ons will be reported separately:

Efficient data management	Data consistency over the entire production process
PM-CONTROL	Flexible parameter management and job control
PM-QUALITY	Batch-based archiving and reporting
Diagnostic management	Higher availability of machines and production plants
PM-MAINT	Intelligent maintenance management system
PM-ANALYZE	Efficient identification of weak points in the process + reporting
Open-mindedness	Consolidation of automation and IT world
PM-OPEN-EXPORT	Automatic export of process data
PM-OPEN-IMPORT	Automatic import of messages and archive values
PM-LOGON	Automatic registration, e.g.: via RFID

[siemens.com/process-management](https://www.siemens.com/process-management)

\\www004.siemens.net\bu01\$\NbgM\PROJ\PROMOTOREN_VM\VM_WARE_WORLD_WITHOUT_UCL\Inst_SW\2019_01_Install_PM_AddOn

Analysis + Reporting with PM-ANALYZE



Archiving, Display and analysis of alarms from several different systems in chronological order

- SIMATIC WinCC V7
- PCS7
- WinCC Comfort / RT Professional
- WinCC Advanced
- WinCC flexible
- Event log of the operating system

- Database and archiving
- Manual input values
- Reporting with Microsoft Excel
- Automatic report generation
- Add-in for Microsoft Excel 2007, 2010, 2013, 2016
 - Access to all process value and summarization archives
 - Access to calculated values and key figures
 - Access to messages and operating actions

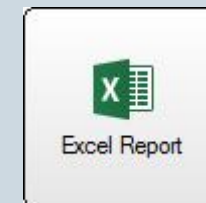

WinCC V7.5 SP1 – Symbol explanations



WinCC single system

S7 system components

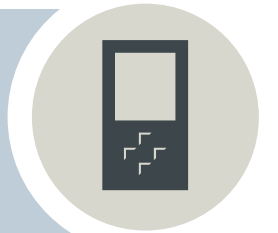

WinCC Server



WinCC Standard-Client

**External database
z.B.: SQL, Oracle, Access**

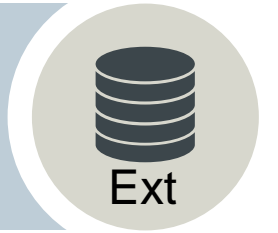

PC without WinCC

Software to be installed on the computer

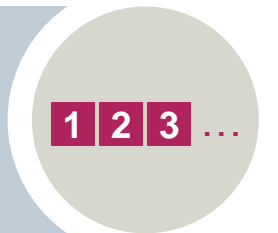

WinCC 7.5 SP1 news

Basic information

- Notes on installation
- Microsoft .NET Framework

Before installing WinCC, make sure the .NET Framework is enabled



- Installations-Medium from WinCC in the Delivery information



- WinCC V7.5 SP1 SP1 – „Installation“



- WinCC V7.5 SP1 SP1 – „Additional Content“ - SQL Server Management Studio
- The SQL Server Management Studio is no longer part of the SQL Server installation and can be found on the enclosed "Additional Content" medium.



- SIMATIC Net PC Software V16

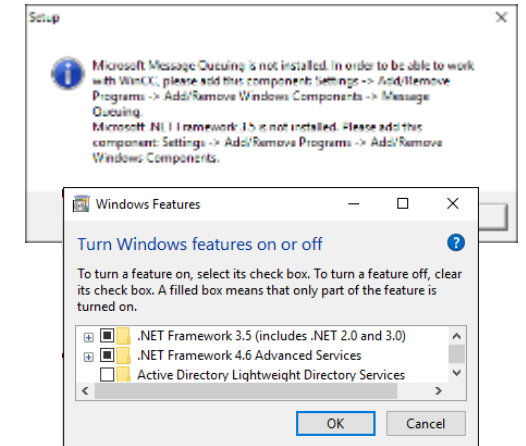

© Siemens AG, 1998 – 2018. All Rights Reserved.

Download Link for SCADA SSP only



[\\ww004.siemens.net\bu01\\$\NbgM\PROJ\PROMOTOREN_VM\VM_WARE_WORLD_WITHOUT_UCL\Inst_SW\2019_11_Install_WinCC_V75_SP1](\\ww004.siemens.net\bu01$\NbgM\PROJ\PROMOTOREN_VM\VM_WARE_WORLD_WITHOUT_UCL\Inst_SW\2019_11_Install_WinCC_V75_SP1)

[\\ww004.siemens.net\bu01\\$\NbgM\PROJ\PROMOTOREN_VM\VM_WARE_WORLD_WITHOUT_UCL\Inst_SW\2019_11_Install_WinCC_V75_SP1_Optionen](\\ww004.siemens.net\bu01$\NbgM\PROJ\PROMOTOREN_VM\VM_WARE_WORLD_WITHOUT_UCL\Inst_SW\2019_11_Install_WinCC_V75_SP1_Optionen)

WinCC V7.5 SP1

Compatibility and General

WinCC Server / single / Clients / WebClients Support **ONLY 64-bit operating systems**

~~Windows 7 SP1 (Professional, Enterprise und Ultimate)~~

- Windows 10 (Professional, Enterprise)
- Windows 10 LTSC 2015/2016, LTSC 2019 (64-Bit)

~~Windows 8.1 (Professional, Enterprise)~~

~~Windows Server 2008 R2 Std SP1 (Standard + Enterprise Edition)~~

- Windows Server 2012 R2 64bit (Datacenter & Standard)
- Windows Server 2016 (Datacenter & Standard)
- Windows Server 2019 (Datacenter & Standard)

- includes more powerful
SQL Server 2016 SP2 64bit



For WinCC WebNavigator and WinCC DataMonitor clients are also released

- Windows 7 SP1 Professional, Enterprise, Ultimate 32-Bit / 64-Bit (but use if is possible Windows 10 *)
- Windows 8.1 Professional, Enterprise 32-Bit / 64-Bit (but use if is possible Windows 10 *)

Release Notes

- Support von MS Office 2013 (64bit) & Microsoft Office 2016 (64bit)
- **DataMonitor Excel Workbook Wizard nur Unterstützung von Office 32Bit Installationen**

***) End of Support from windows 7 / 8.1 (14.01.2020 / 10.01.2023)**

WinCC 7.5 SP1 news

Basic information

- General compatibility
- For integrated operation in the SIMATIC Manager on an engineering station compatible with
 - STEP 7 V5.6 HFx / SP1
- For industrial communication in combination with
 - SIMATIC Net V16

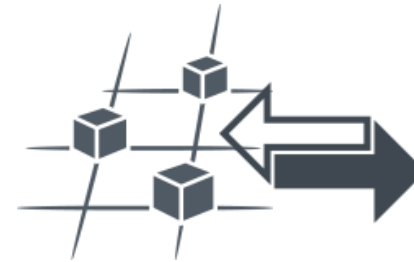

SIEMENS
Ingenuity for life



© Siemens AG, 1998 – 2018. All Rights Reserved.

Notes on installation Compatible tested virus scanner

- Trend Micro "OfficeScan" Client-Server Suite V12.0
- Symantec Endpoint Protection V14 (Norton Antivirus)
- McAfee VirusScan Enterprise V8.8
- McAfee ePolicy Orchestrator (ePO) V5.3.1
- McAfee Agent V5.5
- McAfee Application Control V8.1 (Whitelisting)
- Kaspersky Anti-Virus 2018
- Windows Defender (in the operating system contained version)



WinCC 7.5 SP1 news

Basic information



- Release Notes & General Compatibility
- For linked functionality with DataMonitor "Excel Workbook" Microsoft Excel is needed
- Microsoft Office 2013 SP1 & 2016 32bit
- In order to call the online help of WinCC, it requires Microsoft Internet Explorer
- Internet Explorer from V11.0 32-Bit
- Run on virtualization server ESXi 6.5, 6.7 & Hyper-V 2012/2016/2016
- The system requirements vary depending on the type of the selected WinCC installation and used Operating system.
Support for all current IBM / AT PC platforms. WinCC always relies on current operating systems and high security requirements



<https://support.industry.siemens.com/cs/ww/en/view/109745988>

WinCC V7.5 SP1

Upgrading WinCC licenses

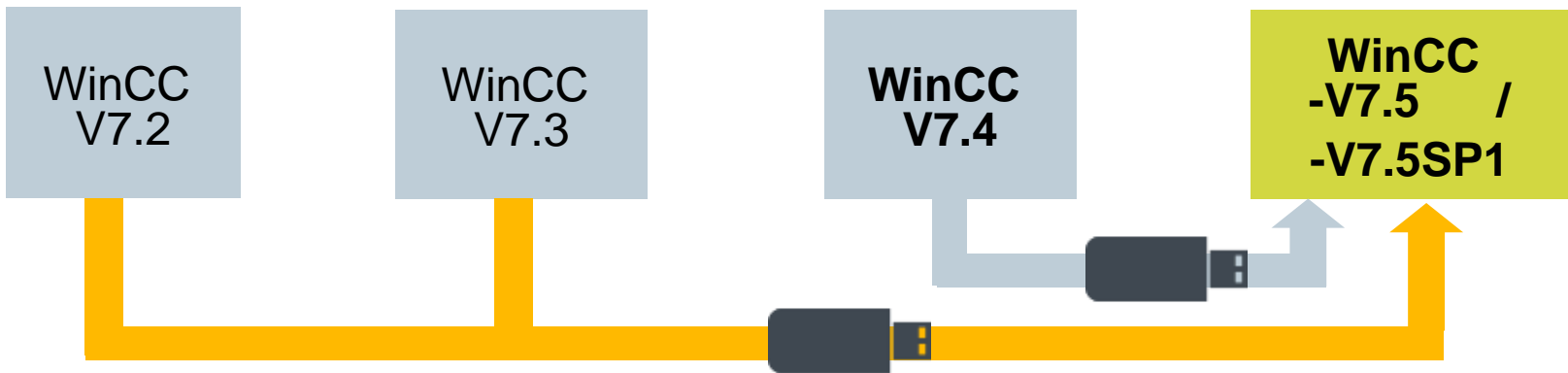

- More favorable conditions if the customer already has the recent WinCC Version

cheaper in comparison with the DVD version

Link to OSD

[Online Software Delivery](#)

Link to the compatibility tool

<https://support.industry.siemens.com/cs/sc/2055/compatibilityTool>



WinCC V7 upgrade	Bestellnummer DVD	Bestellnummer download
Upgrade RT-Version, V7.2/7.3 -> V7.5 SP1	6AV6381-2AA07-5AX3	6AV6381-2AA07-5AK3
Upgrade RT-Version, V7.4 -> V7.5 SP1	6AV6381-2AA07-5AX4	6AV6381-2AA07-5AK4
Upgrade Client RT-Version, V7.2/7.3 -> V7.5 SP1	6AV6381-2CA07-5AX3	6AV6381-2CA07-5AK3
Upgrade Client RT-Version, V7.4 -> V7.5 SP1	6AV6381-2CA07-5AX4	6AV6381-2CA07-5AK4
Upgrade RC-Version, V7.2/7.3 -> V7.5 SP1	6AV6381-2AB07-5AX3	6AV6381-2AB07-5AK3
Upgrade RC-Version, V7.4 -> V7.5 SP1	6AV6381-2AB07-5AX4	6AV6381-2AB07-5AK4
Upgrade Client RC-Version, V7.2/7.3 -> V7.5 SP1	6AV6381-2CB07-5AX3	6AV6381-2CB07-5AK3
Upgrade Client RC-Version, V7.4 -> V7.5 SP1	6AV6381-2CB07-5AX4	6AV6381-2CB07-5AK4

WinCC V7.5 SP1

Compatibility and General (continued)

Side-by-side-Installation with other SIMATIC-Products

- Compatible with STEP 7 V5.4/V5.5/V5.6, V10.5/V11/V12,V13,14,14SP1,V15,15.1,V16
WinCC flexible (from 2008)

WinCC V7.5 SP1 SP1 can't be installed together with **WinCC Professional, WinCC Unified und WinCC V6 / V7.x.**

- **Remote-Software** (→ [Link](#))
- **Remote Desktop Connection (RDP)** in console mode (for WinCC clients release)
(If WinCC Server is running in service mode)
- "RealVNC" Enterprise Edition V5.1.0

WinCC V7.5 SP1 – Compatible operating systems

	Server	Single system	Client without Projekt	Client with Projekt
Windows <ul style="list-style-type: none">• 10	Max. 3 Clients without redundancy 			
Windows Server <ul style="list-style-type: none">• 2012 R2• 2016• 2019•				

WinCC V7.5 SP1 – Recommended / Compatible Operating Systems for Web Solutions

**WebNavigator
Client**

**DataMonitor
Client**

Windows

- 7 *)
- 8.1 *)
- 10



Windows Server

- 2012 R2
- 2016
- 2019



***) End of Support from windows 7 / 8.1 (14.01.2020 / 10.01.2023)**

WinCC V7.5 SP1– Lizenzen



RT- and RC-Lizenzen

WinCC differentiates between RT licenses (Runtime) and RC licenses (Runtime and Configuration) as well as the number of variables (tags).

RT licenses entitle you to unlimited use of WinCC in runtime.

The use of the editors is only possible in demo mode with a time limit.

- **RC-Lizenzen berechtigen zum zeitlich unbegrenzten Einsatz von WinCC in Runtime und bei der Projektierung.**

RC licenses can be used locally or remotely. If an RC license is on a different computer, use is only permitted for the configuration. If you want to use Runtime, the RC license must be available locally or you also need an RT license.

How many external variables and archive tags are allowed for the configuration is shown by the number in the parenthesis, for example: Eg "WinCC RC (65536)". With this license, you can use up to $64 * 1024$ external tags and up to 512 archive tags in runtime.

If you activate a project in which the number of external variables or archive variables exceeds the number of permitted variables, the demo mode is activated.

The system then behaves as if the licenses were completely missing

WinCC V7.5 SP1 Basic station – order number for SIMATIC WinCC V7.5 SP1...



WinCC V7.5 SP1 (RC = RT and Engineering (n tags) inkl. 512 archiv tags)

description	Order number EU		Order number
	DVD	Online Software Download	DVD
WinCC RC 128	6AV6381-2BM07-5AX0	6AV6381-2BM07-5AH0	6AV6381-2BM07-5AV0
WinCC RC 512	6AV6381-2BN07-5AX0	6AV6381-2BN07-5AH0	6AV6381-2BN07-5AV0
WinCC RC 2048	6AV6381-2BP07-5AX0	6AV6381-2BP07-5AH0	6AV6381-2BP07-5AV0
WinCC RC 8192	6AV6381-2BS07-5AX0	6AV6381-2BS07-5AH0	6AV6381-2BS07-5AV0
WinCC RC 65536	6AV6381-2BQ07-5AX0	6AV6381-2BQ07-5AH0	6AV6381-2BQ07-5AV0
WinCC RC 102400	6AV6381-2BT07-5AX0	6AV6381-2BT07-5AH0	6AV6381-2BT07-5AV0
WinCC RC 153600	6AV6381-2BU07-5AX0	6AV6381-2BU07-5AH0	6AV6381-2BU07-5AV0
WinCC RC 262144	6AV6381-2BV07-5AX0	6AV6381-2BV07-5AH0	6AV6381-2BV07-5AV0
WinCC RC Client	6AV6381-2CB07-5AX0	6AV6381-2CB07-5AH0	6AV6381-2CB07-5AV0

WinCC V7.5 SP1 Runtime (RT inkl. 512 archiv tags)

description	Order number EU		Order number ASIA
	DVD	Online Software Download	DVD
WinCC RT 128	6AV6381-2BC07-5AX0	6AV6381-2BC07-5AH0	6AV6381-2BC07-5AV0
WinCC RT 512	6AV6381-2BD07-5AX0	6AV6381-2BD07-5AH0	6AV6381-2BD07-5AV0
WinCC RT 2048	6AV6381-2BE07-5AX0	6AV6381-2BE07-5AH0	6AV6381-2BE07-5AV0
WinCC RT 8192	6AV6381-2BH07-5AX0	6AV6381-2BH07-5AH0	6AV6381-2BH07-5AV0
WinCC RT 65536	6AV6381-2BF07-5AX0	6AV6381-2BF07-5AH0	6AV6381-2BF07-5AV0
WinCC RT 102400	6AV6381-2BJ07-5AX0	6AV6381-2BJ07-5AH0	6AV6381-2BJ07-5AV0
WinCC RT 153600	6AV6381-2BK07-5AX0	6AV6381-2BK07-5AH0	6AV6381-2BK07-5AV0
WinCC RT 262144	6AV6381-2BL07-5AX0	6AV6381-2BL07-5AH0	6AV6381-2BL07-5AV0
WinCC RT Client	6AV6381-2CA07-5AX0	6AV6381-2CA07-5AH0	6AV6381-2CA07-5AV0

WinCC WebNavigator and DataMonitor V7.5 SP1 – Order number



WinCC WebNavigator (countable)

description	Order number DVD – EU	Online Software Download – EU	Order number DVD – ASIA
WinCC WebNavigator – 1 Client	6AV6362-1AB00-0BB0	6AV6362-1AB00-0AH0	6AV6362-1AB00-0BB0
WinCC WebNavigator – 3 Clients	6AV6362-1AD00-0BB0	6AV6362-1AD00-0AH0	6AV6362-1AD00-0BB0
WinCC WebNavigator – 10 Clients	6AV6362-1AF00-0BB0	6AV6362-1AF00-0AH0	6AV6362-1AF00-0BB0
WinCC WebNavigator – 30 Clients	6AV6362-1AJ00-0BB0	6AV6362-1AJ00-0AH0	6AV6362-1AJ00-0BB0
WinCC WebNavigator – 100 Clients	6AV6362-1AM00-0BB0	6AV6362-1AM00-0AH0	6AV6362-1AM00-0BB0
WinCC WebNavigator Load Balancing	6AV6362-1FA00-0BB0	6AV6362-1FA00-0AH0	6AV6362-1FA00-0BB0
WinCC WebNavigator Load Balancing Step Up	6AV6362-1GA00-0BB0	6AV6362-1GA00-0AH0	6AV6362-1GA00-0BB0
WinCC WebNavigator Diagnostic Client	6AV6362-1BA00-0BB0	6AV6362-1BA00-0AH0	6AV6362-1BA00-0BB0

WinCC DataMonitor (countable)

description	Order number DVD – EU	Online Software Download – EU	Order number DVD – ASIA
WinCC DataMonitor – 1 Client	6AV6362-3AB00-0BB0	6AV6362-3AB00-0AH0	6AV6362-3AB00-0BB0
WinCC DataMonitor – 3 Clients	6AV6362-3AD00-0BB0	6AV6362-3AD00-0AH0	6AV6362-3AD00-0BB0
WinCC DataMonitor – 10 Clients	6AV6362-3AF00-0BB0	6AV6362-3AF00-0AH0	6AV6362-3AF00-0BB0
WinCC DataMonitor – 30 Clients	6AV6362-3AJ00-0BB0	6AV6362-3AJ00-0AH0	6AV6362-3AJ00-0BB0

Integrated licensing concept

NEW as of WinCC V7.4 / RT Professional V14

Web solutions with WebNavigator and WebUX

In the future, these SCADA options will have **standardized MLFBs as of V7.4 or V14** and therefore there will no longer be any in-house MLFBs for **WinCC V7.5 SP1 / RT Professional V16**

Note: WebNavigator / DataMonitor licenses as of V7.4 can no longer be used for WinCC V7.3 WebNavigator / DataMonitor or older

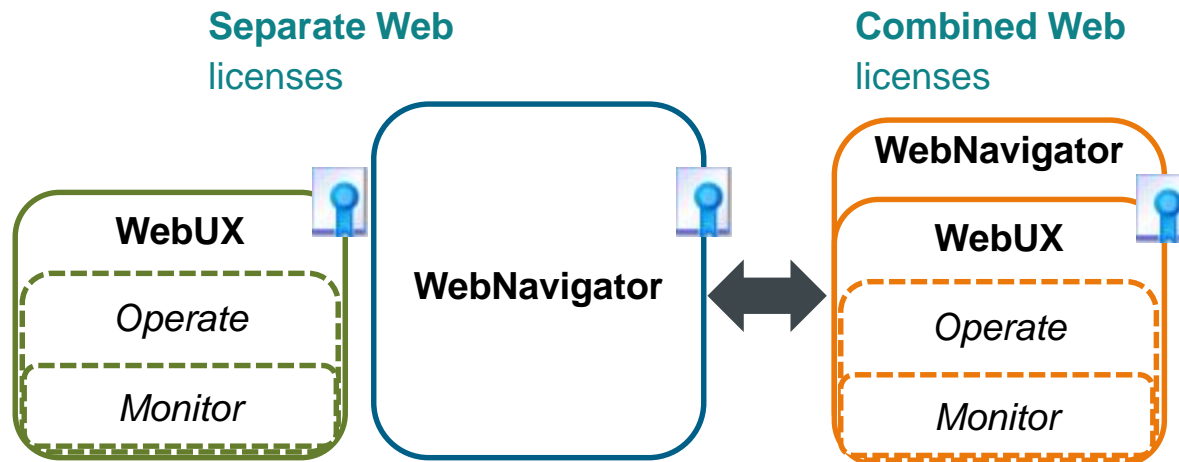

Scalable web access

Switching between two license models:

- Separate or combined Web-licenses
WebUX Monitor Client (read only)
WebUX Operate Client (read-write)
Web Navigator Client (read-write)

Web Licenses are additive:

- all WebClients = sum of the individual licenses (**countable**)
- (1, 3, 10, 30, 100 clients)
- Reserving licenses for users
- No update costs, because version-independent licenses (existing licenses remain valid after upgrade)

1x WinCC WebUX Monitor Client FREE!

WinCC WebUX V7.5 SP1 / WinCC RT Professional V16

Order number



WinCC WebUX (Monitor: Countable)

description	Order number DVD – EU	Online Software Download – EU	Order number DVD – ASIA
WinCC WebUX Monitor 1 Client	6AV6362-2AB00-0BB0	6AV6362-2AB00-0AH0	6AV6362-2AB00-0BB0
WinCC WebUX Monitor 3 Clients	6AV6362-2AD00-0BB0	6AV6362-2AD00-0AH0	6AV6362-2AD00-0BB0
WinCC WebUX Monitor 10 Clients	6AV6362-2AF00-0BB0	6AV6362-2AF00-0AH0	6AV6362-2AF00-0BB0
WinCC WebUX Monitor 30 Clients	6AV6362-2AJ00-0BB0	6AV6362-2AJ00-0AH0	6AV6362-2AJ00-0BB0
WinCC WebUX Monitor 100 Clients	6AV6362-2AM00-0BB0	6AV6362-2AM00-0AH0	6AV6362-2AM00-0BB0

WinCC WebUX (Monitor and Operate: Countable)

description	Order number DVD – EU	Online Software Download – EU	Order number DVD – ASIA
WinCC WebUX Operate 1 Client	6AV6362-2BB00-0BB0	6AV6362-2BB00-0AH0	6AV6362-2BB00-0BB0
WinCC WebUX Operate 3 Clients	6AV6362-2BD00-0BB0	6AV6362-2BD00-0AH0	6AV6362-2BD00-0BB0
WinCC WebUX Operate 10 Clients	6AV6362-2BF00-0BB0	6AV6362-2BF00-0AH0	6AV6362-2BF00-0BB0
WinCC WebUX Operate 30 Clients	6AV6362-2BJ00-0BB0	6AV6362-2BJ00-0AH0	6AV6362-2BJ00-0BB0
WinCC WebUX Operate 100 Clients	6AV6362-2BM00-0BB0	6AV6362-2BM00-0AH0	6AV6362-2BM00-0BB0

Please note the limited number of connections for Windows desktop operating systems

WinCC V7.5 SP1? – In which use case V7 or RT Professional ?

Quantity structure

18 Server each with 64 Clients or 50 Multiclient

Distributed system architecture

- with Multi-Clients
- WebNavigator Load balancing

WinCC RT Professional V16 does not extend the range of functions

- No multiclient available
- Extended archiving (database, size, etc. ...)
- Dynamic properties in SVG graphics missing
- WinCC V7 becomes the standard gateway for smart data in cloud solutions Integrated communication with the cloud through the standardized MQTT protocol
- WebUX (Faceplate)
- Telecontrol Option missing
- WinCC Audit



Standard monitoring function

- **System Tags for Performance Monitoring**
- Real-time information for archiving and communication connections
 - Efficient Engineering:
 - **new Tag Simulator** with significantly extended functionality
 - New Symbol Fonts for example “Font Awesome
 - Support of the S7-1500 R / H
 - Simulation of external Tags

WinCC V7.5 SP1 – New: System diagnostics with performance tags

- To analyze the WinCC project, WinCC provides the system variables "@PRF _...".
- This allows you to evaluate the time behavior of the server
- The WinCC Tag Management creates the system tags when creating a WinCC project. As soon as you create a new connection under a communication driver, additional performance variables are created for this connection.

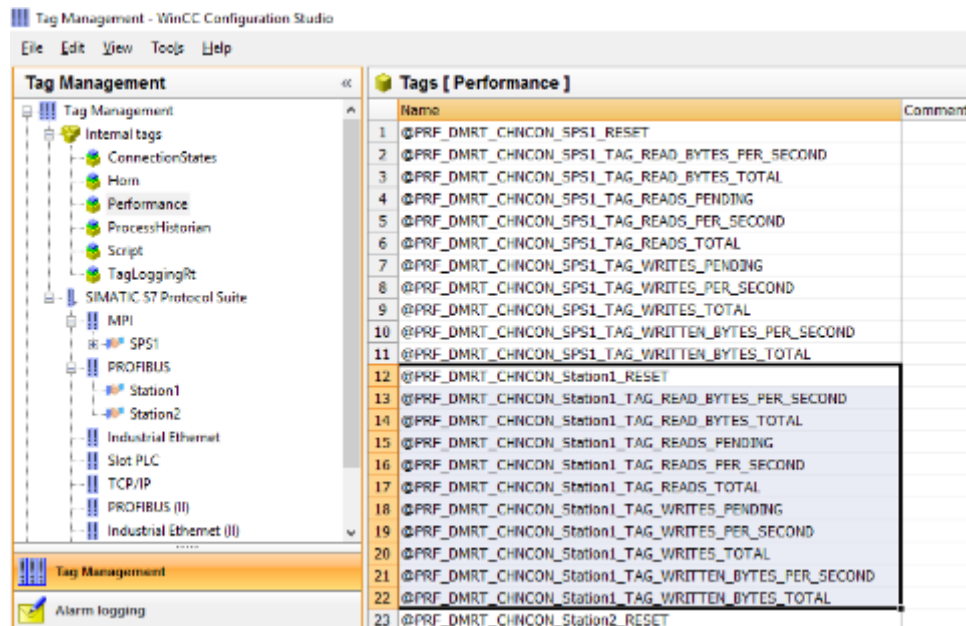

Windows Performance Monitor

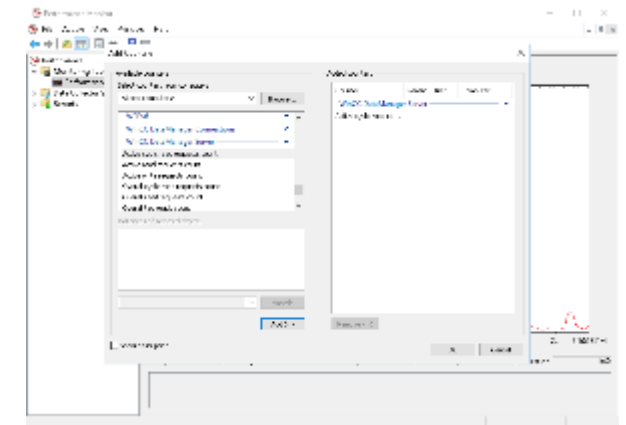

WinCC V7.5 SP1 Scalability – Configuration principle and function tasks

Summery quantity structure – Following configurations were tested as typical scenarios

	Quantity	Comment
WinCC Server-Server communication	18 Server	<p>Connection to a multi-user system with MULIT-Clients has not been approved</p> <ul style="list-style-type: none"> • One server can access the data from up to 17 other servers or redundant pairs of servers • The server accessing the data behaves as a client in respect of the configuration and operation, except that a standard server cannot be configured
WinCC Server or redundant Server pairs	18 Servers	Access to a maximum of 18 WinCC servers or redundant server pairs from WinCC MULTI-Clients
WinCC UNI-Clients (without their own project)	64 Clients	<p>Maximum of 64 WinCC UNI-Clients interconnect to one Server</p> <ul style="list-style-type: none"> • Redundant server pairs are possible
WinCC MULTI-Clients (with their own project)	50 Clients	<p>Maximum of 50 WinCC MULTI-Clients in the WinCC distributed system</p> <ul style="list-style-type: none"> • A maximum of 36 servers in the form of 18 redundant server pairs is possible
WinCC WebN.-Clients	150 Clients	
WinCC WebUX-Clients	100 Clients	<p>As a typical scenario, we tested the simultaneous access of 100 WebUX clients to one WebUX server</p> <ul style="list-style-type: none"> • 100 clients are not a “hard” system limit – it is technically possible to connect more than 100 clients simultaneously • The performance depends on the employed hardware and the volume of process data

WinCC V7.5 SP1 Scalability

Configuration principle & function tasks

Configuration of mixed systems (means minimum one UNI- & one MULTI-Client exist in the system)

- Different quantity structures can be realized according to the type and number of client types used.
- Mixed systems are possible, meaning the parallel use of clients with and without Web Clients within one client/server system.
- When configuring a mixed system, the following rule* of thumb should be observed to achieve the maximum quantity structures:
 - Each client type has one value:
 - WebNavigator-Client / Thin-Client = 1
 - WebUX-Client / MULIT & UNI-Client = 2
 - UNI-Client with the "Configure remote" function = 4
 - The total of all values of all clients should not exceed 120 per server in the case of WinCC servers without operating function
 - In the case of servers with operating function, the total value should not exceed 32.

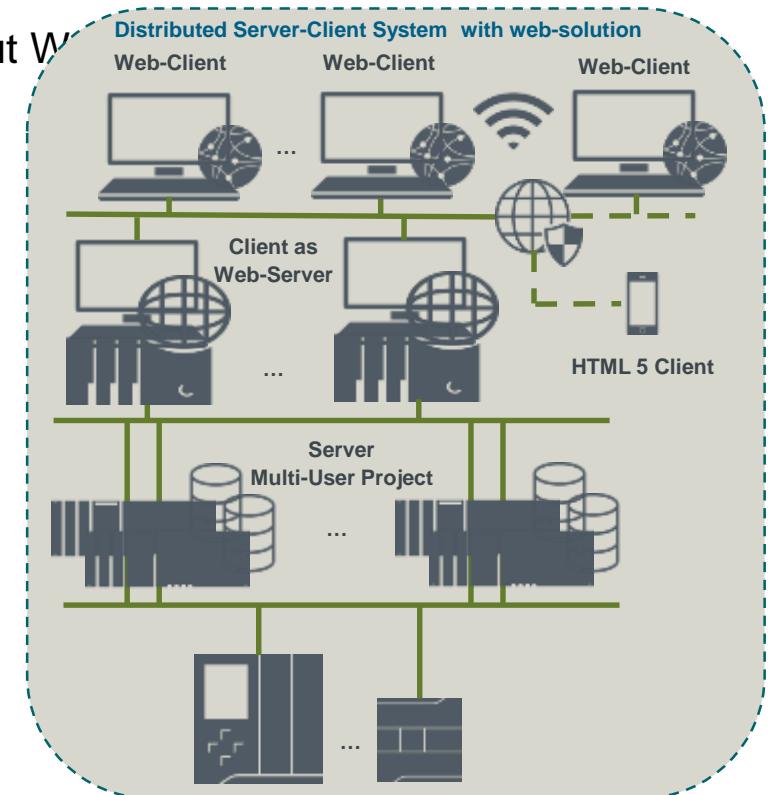

WinCC V7.5 SP1 process communication

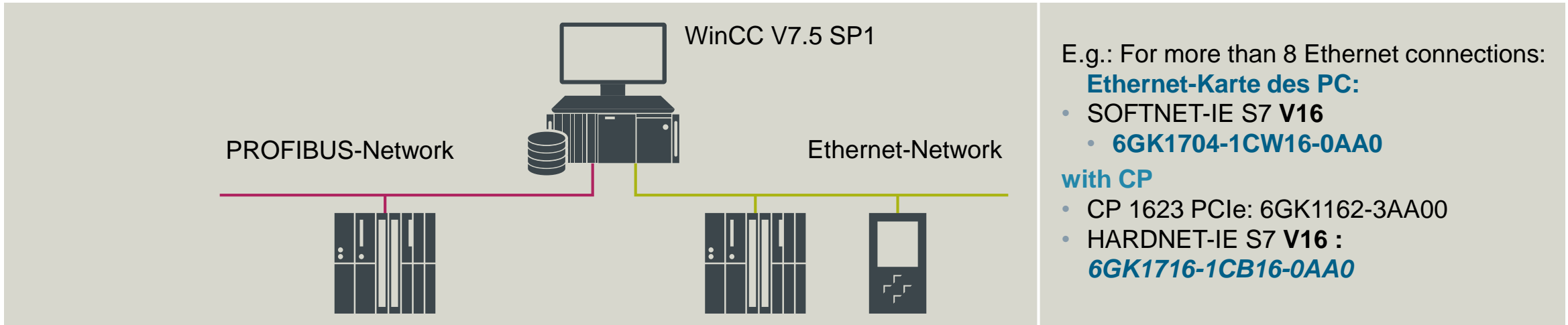

E.g.: For more than 8 Ethernet connections:

Ethernet-Karte des PC:

- SOFTNET-IE S7 V16
- **6GK1704-1CW16-0AA0**

with CP

- CP 1623 PCIe: 6GK1162-3AA00
- HARDNET-IE S7 V16 :
6GK1716-1CB16-0AA0

CP 5621 PCIe Softnet Grid size

- Protocol operating distance Multi Point Interface/PROFIBUS included in WinCC

CP 5613 A2 PCIe Hardnet Grid size

- Protocol operating distance Multi Point Interface/PROFIBUS a license is required

PC Ethernet Board

- Protocols 1200/1500, S7 TCP/IP, Ind. Eth
- Licences: Softnet S7 Lean/Basis included in WinCC 8 connections max.
 - **128 x S7-1500** connections max.
 - **64 x S7-1200** connections max.
 - **64 x S7-300/400** connections max.
- IF > **8 connections** → Softnet-IE S7 license required or
- **CP 1623/1628 PCIe + Licences für Hardnet-IE S7**
- (S7 1613) required

WinCC V7.5 SP1 process communication

The included communication drivers do not require an additional license:

- Allen Bradley - Ethernet IP
- Mitsubishi Ethernet / iQF PLC
- Modbus TCP/ IP
- OPC
- OPC UA
- PROFIBUS DP
- SIMATIC 505 TCP/IP



- SIMATIC S7 Protocol Suite
- SIMATIC S7-1200, S7-1500
- SIMATIC TI Ethernet Layer 4
- SIMATIC TI Serial
- SIMOTION
- System Info



- SIMATIC S5 Ethernet Layer 4
- SIMATIC S5 Profibus FDL
- SIMATIC S5 Programmers Port AS511
- SIMATIC S5 Serial 3964R



WinCC V7.5 SP1

Extended support of the S7-1500 R / H

Increased availability and reliability through redundant automation systems with S7-1500R / H controllers



Communication via Symbol-IP-Address

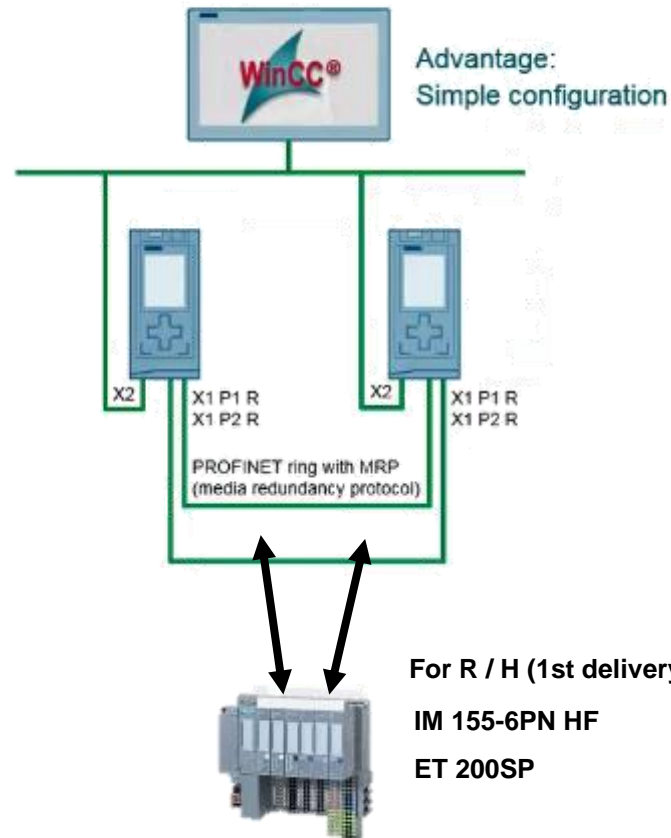

"Software redundancy" Communication via Device-IP-Address

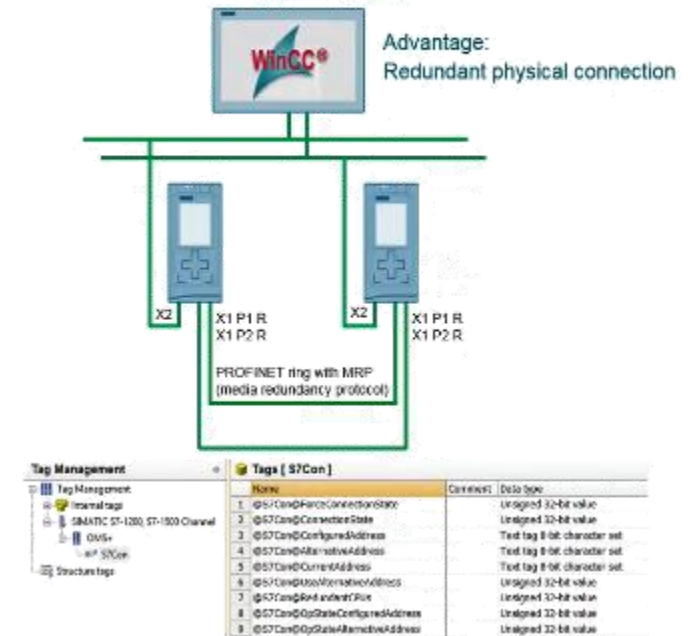

Communication with R / H
Systems by using the
"System IP Address"

WinCC V7.5 SP1 Communication S7-1500 H/R - with the System-IP

The System-IP has to be configured. The HMI-Connection will be configured with the IP-Address.

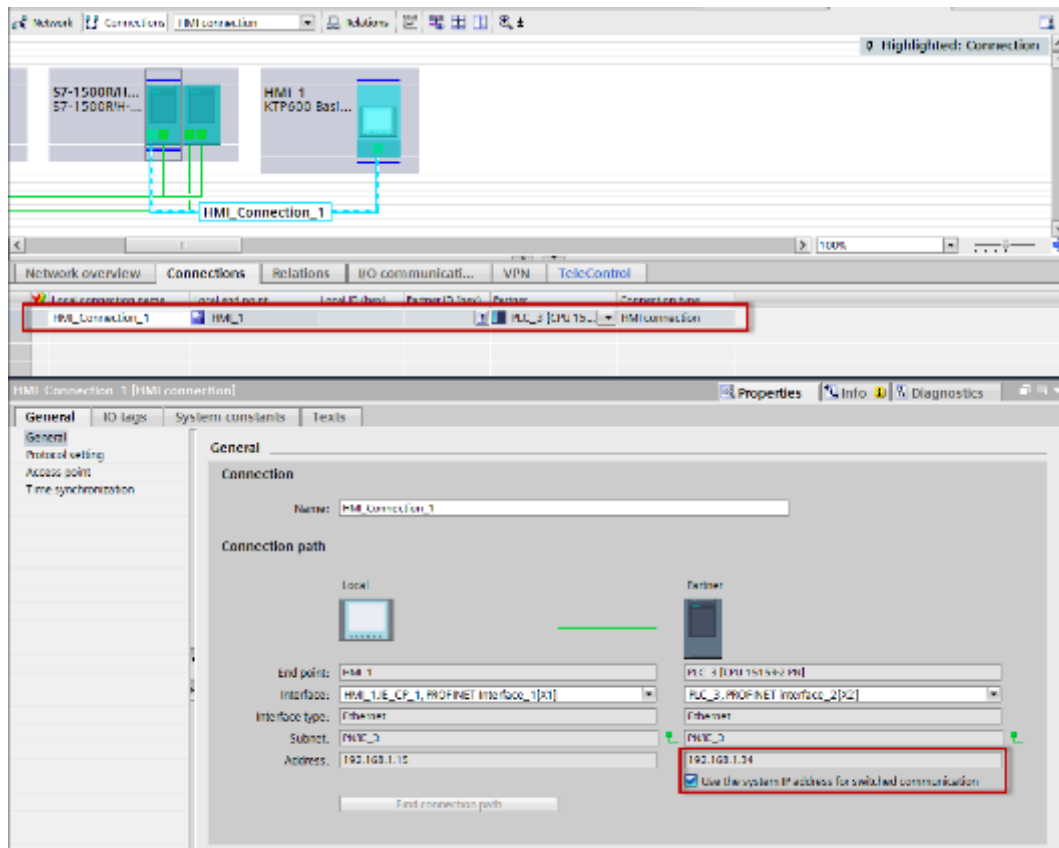

Single-user station – Monitoring/Operating from a single PC

Single-user station
WinCC V7.5 SP1
engineering-Station + RT

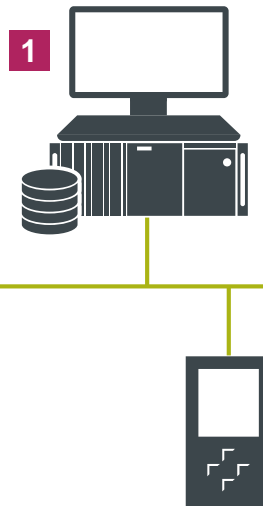

Additional Information

Quantity:

Process Variables: Up to 262 144 (depending on the license selected)

Archiving variables: **Max. 80 000** (based on the WinCC Tag Logging option)
(Reminder: The WinCC V7.5 SP1 base includes 512 archiving variables)

1

WinCC V7.5 SP1

WinCC V7.5 SP1 RC / RT n

z.B.

- WinCC V7.5 SP1 128
- WinCC V7.5 SP1 512
- WinCC V7.5 SP1 2048
- WinCC V7.5 SP1 8192
- WinCC V7.5 SP1 65 536
- WinCC V7.5 SP1 102 400
- WinCC V7.5 SP1 153 600
- WinCC V7.5 SP1 262 144

SIMATIC Net V16

Redundant Single-user stations – 2 monitoring/operating stations with high availability

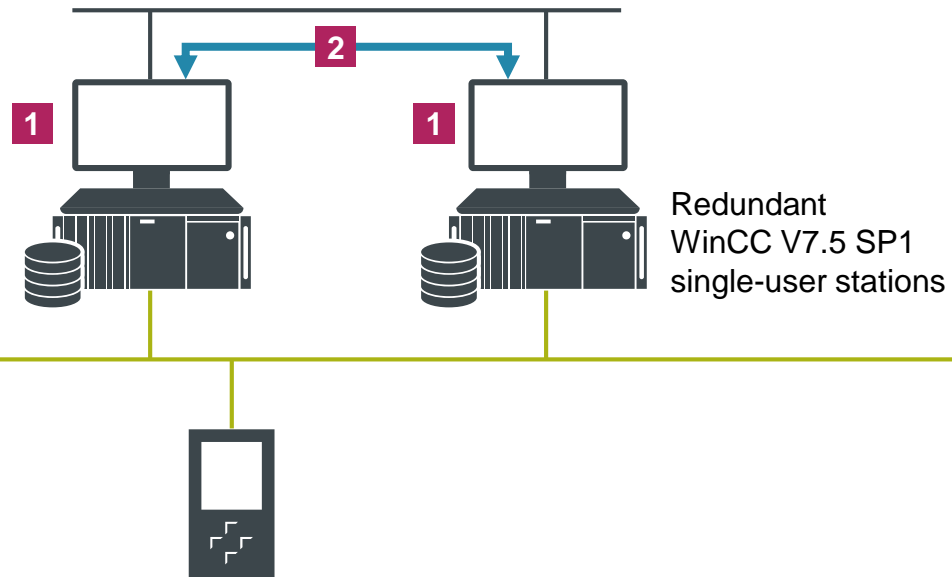

1 WinCC V7.5 SP1

WinCC V7.5 SP1 RT n
SIMATIC Net V16

2 WinCC Redundancy

MLFB: 6AV6371-1CF07-5AX0

Additional Information

Both stations work in parallel (both are connected to the process). In case of a breakdown of one of the 2 WinCC stations, the other takes over the archiving of messages, process Data and user archive data (Recipe). Automatic synchronization of all archives after resumption of normal operation.

redundant engineering single-user stations

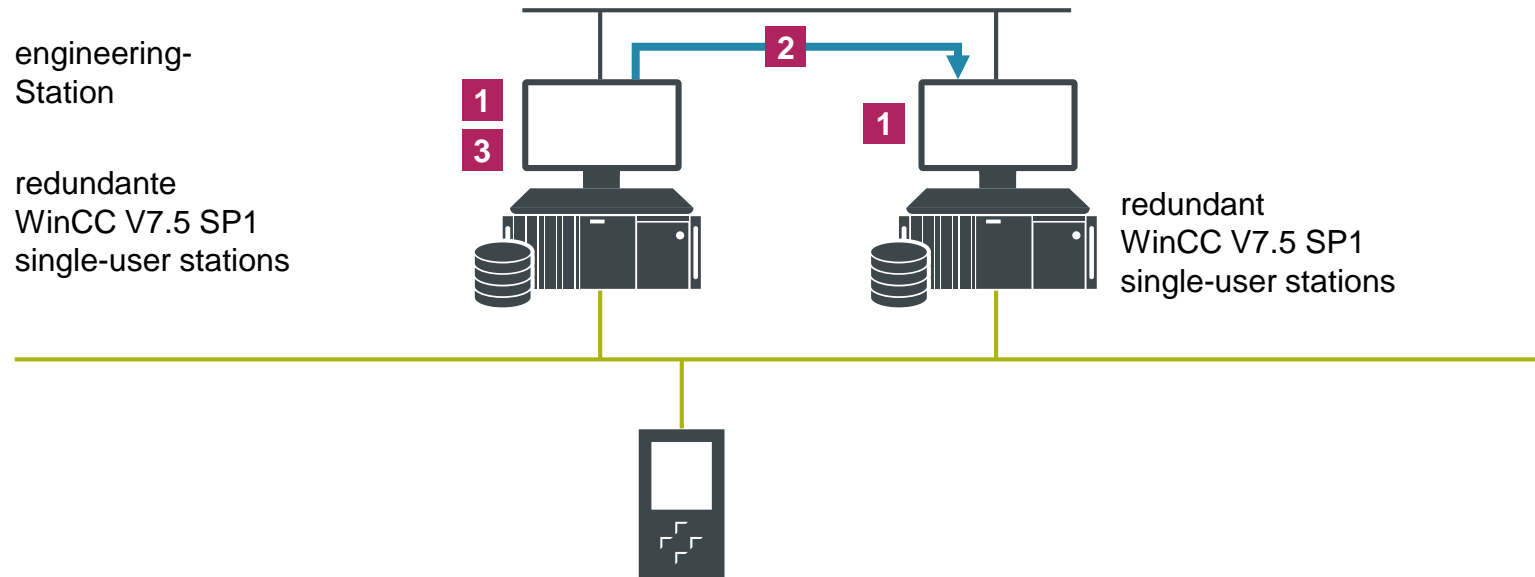

Please note

WinCC V7.5 SP1 RC license has to be installed at one station to implement modifications (longer than 1h) to the WinCC project.

1 WinCC V7.5 SP1

WinCC V7.5 SP1 RT n
SIMATIC Net V16

2 WinCC Redundancy

MLFB: 6AV6371-1CF07-5AX0

3 WinCC Engineering

WinCC V7.5 SP1 RC n

Multi-user stations – Central server with monitoring / operation stations – Standard client (UNI-Client)

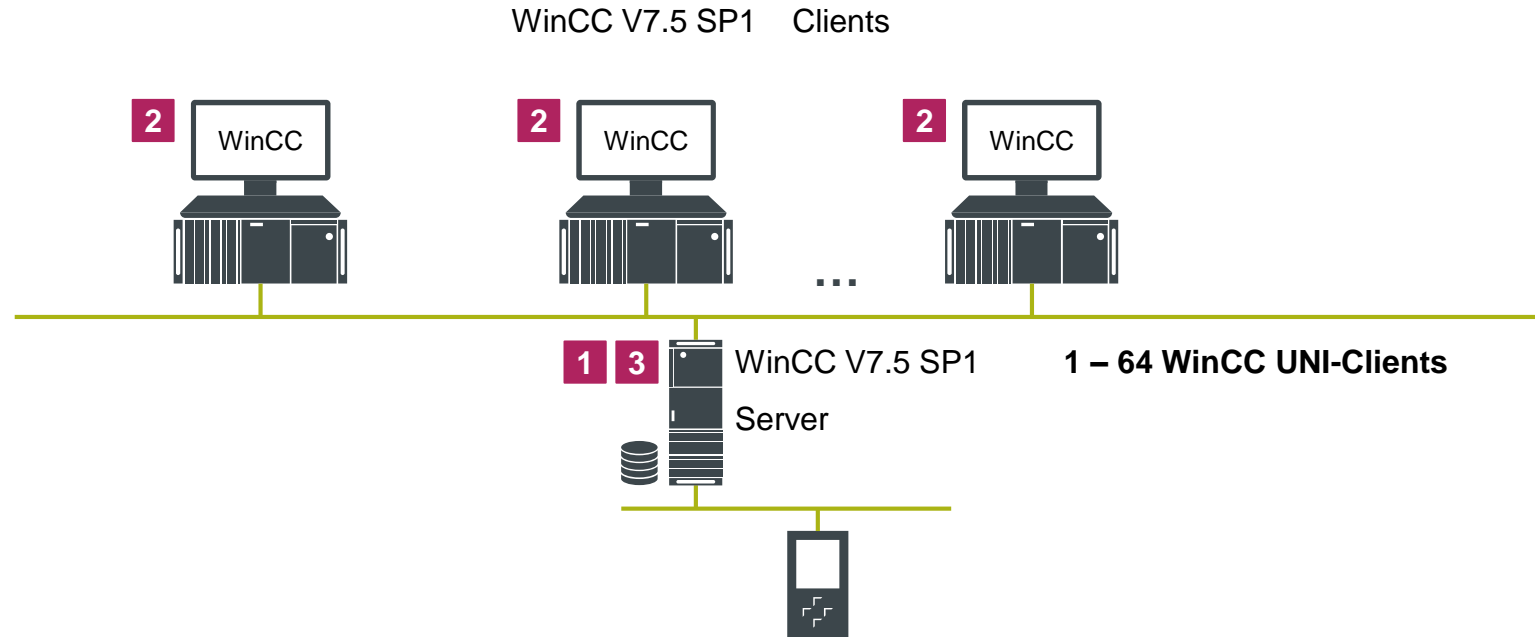

- 1** WinCC V7.5 SP1
WinCC V7.5 SP1 RT n
SIMATIC Net V16
- 2** WinCC Client
MLFB: 6AV6381-2CA07-5AX0
- 3** WinCC Server
MLFB: 6AV6371-1CA07-5AX0

Please note

A Standard Client has no WinCC project and is connected to a very specific server from which he retrieves data and views.

Multi-user stations – Central server with monitoring/operation station – MULTI-Clients

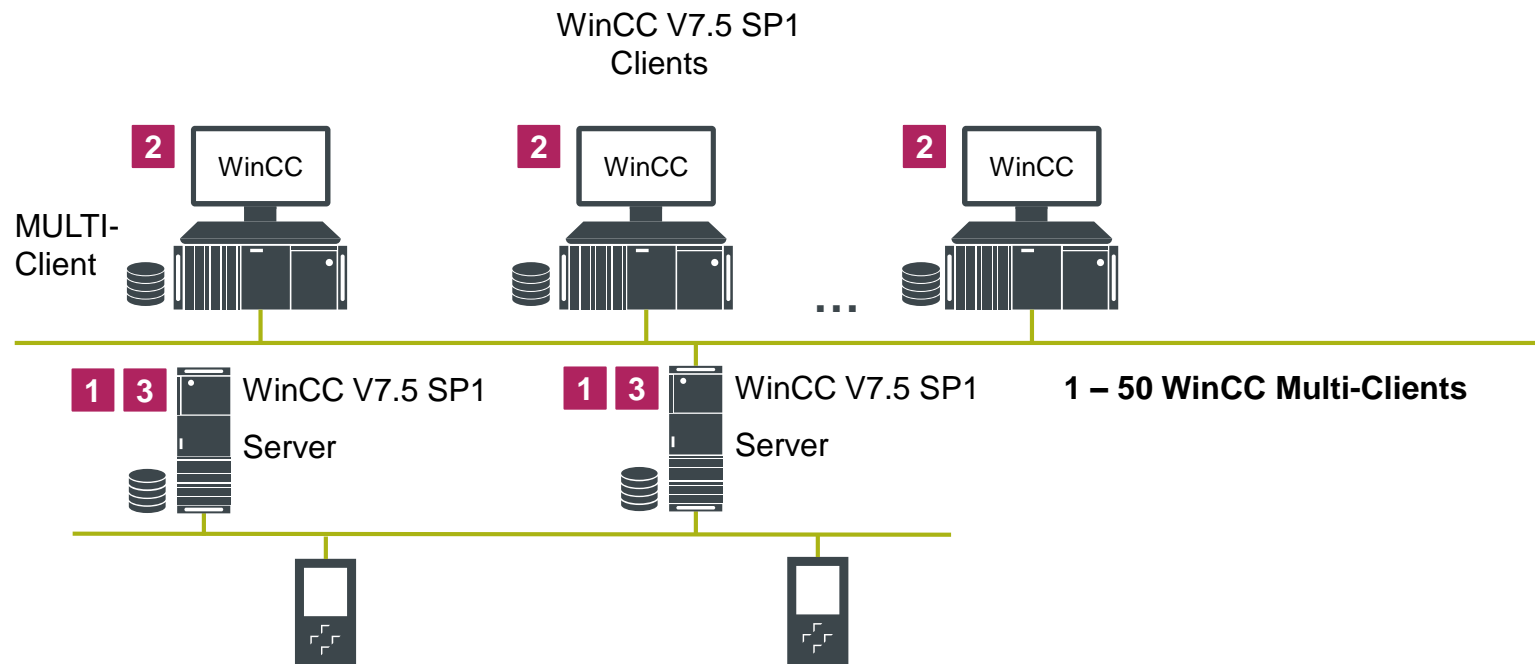

- 1** WinCC V7.5 SP1
WinCC V7.5 SP1 RT n
SIMATIC Net V16
- 2** WinCC Client
MLFB: 6AV6381-2CA07-5AX0
- 3** WinCC Server
MLFB: 6AV6371-1CA07-5AX0

Please note

A MULTI Client with their own WinCC project and is connected to a very specific server from which he retrieves data and views.

Multi-user stations with multi clients1) – Engineering – Deployment on the server

Case 1: The Engineering license is on the server.
You can work directly on the project located on the server to make changes

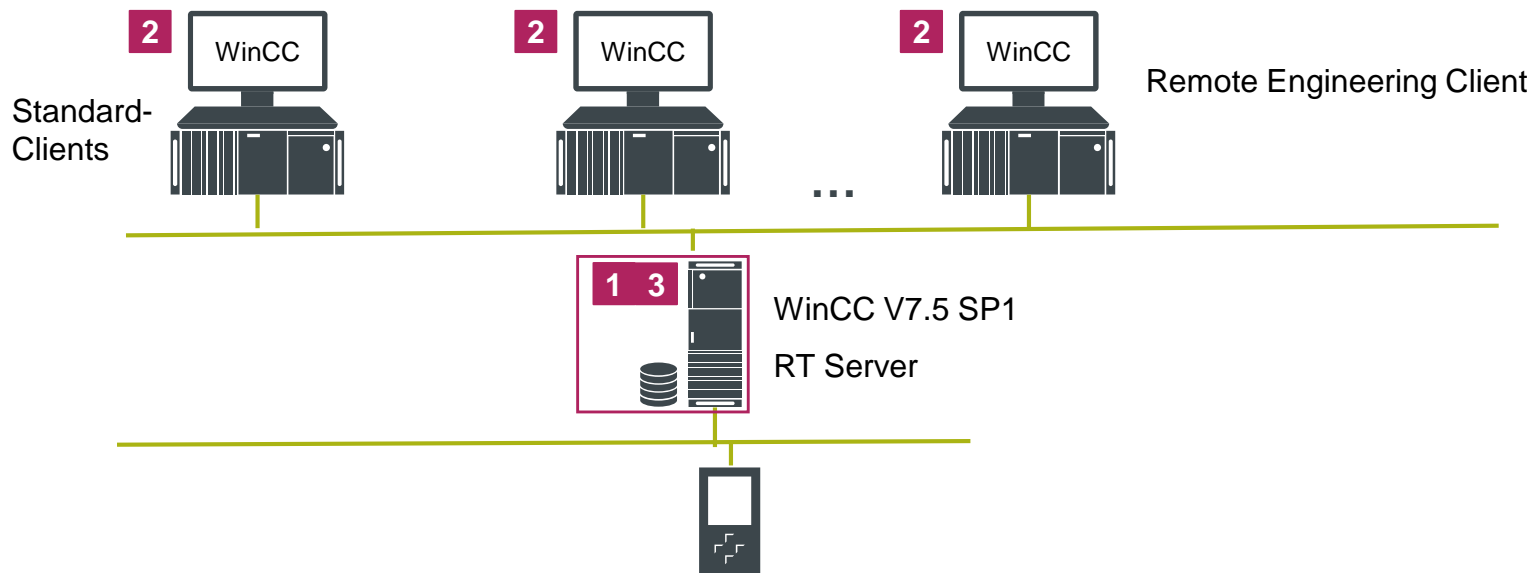

Please note: Differences relative to the preceding case

The Engineering license (RC) must be added on the server.
In case of changes, some changes may require shutting down the server.
Furthermore, any inadvertent error may cause the server to crash!

1	WinCC V7.5 SP1
	WinCC V7.5 SP1 RT n
2	WinCC Client
	MLFB: 6AV6381-2CA07-5AX0
3	WinCC Server
	MLFB: 6AV6371-1CA07-5AX0
4	WinCC Engineering
	RC Client :
	MLFB: 6AV6381-2CB07-5AX0

Multi-Client stations/Server with Redundancy – High availability

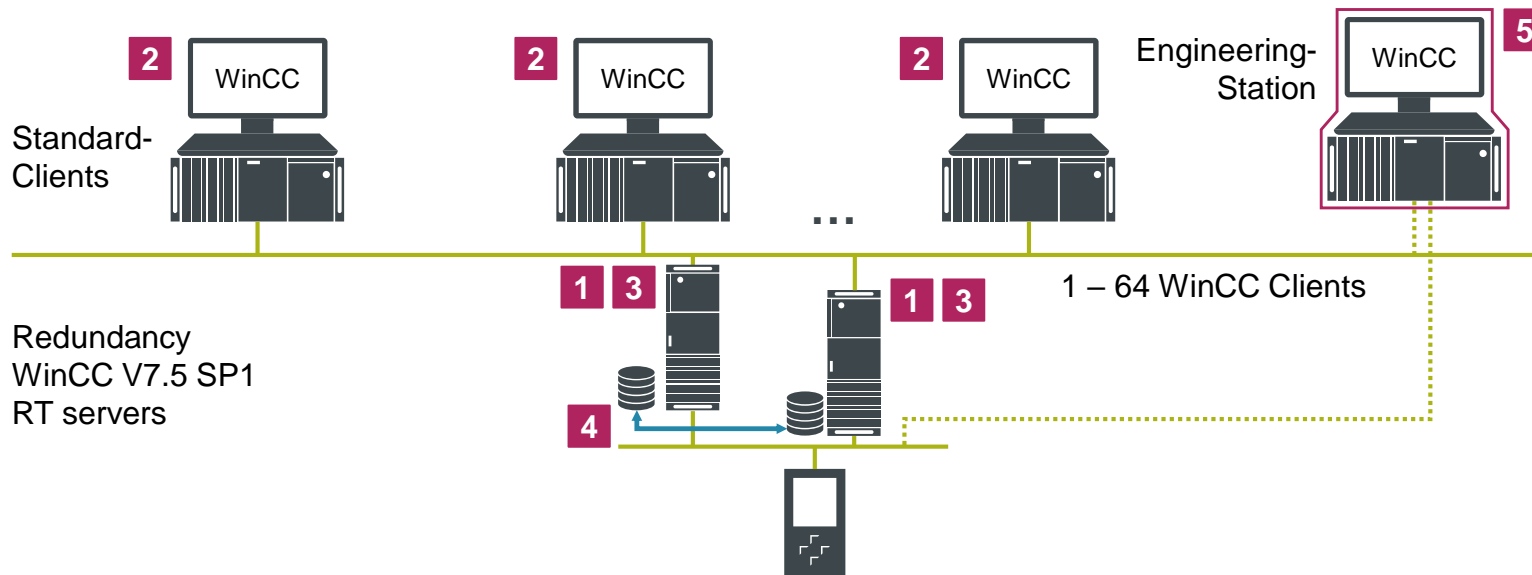

Please note

Due to the redundancy of the servers, the Clients can continue to work in case of a server crash. The data are synchronized across the servers and the database is **entirely** replicated when operations return to normal.

1 WinCC V7.5 SP1

WinCC V7.5 SP1 RT n
SIMATIC Net V16

2 WinCC Client

MLFB: 6AV6381-2CA07-5AX0

3 WinCC Server

MLFB: 6AV6371-1CA07-5AX0

4 WinCC Redundancy

MLFB: 6AV6371-1CF07-5AX0

5 WinCC Engineering

WinCC V7.5 SP1 RC n

Dedicated archives server (SIMATIC ProcessHistorian) – Data archiving

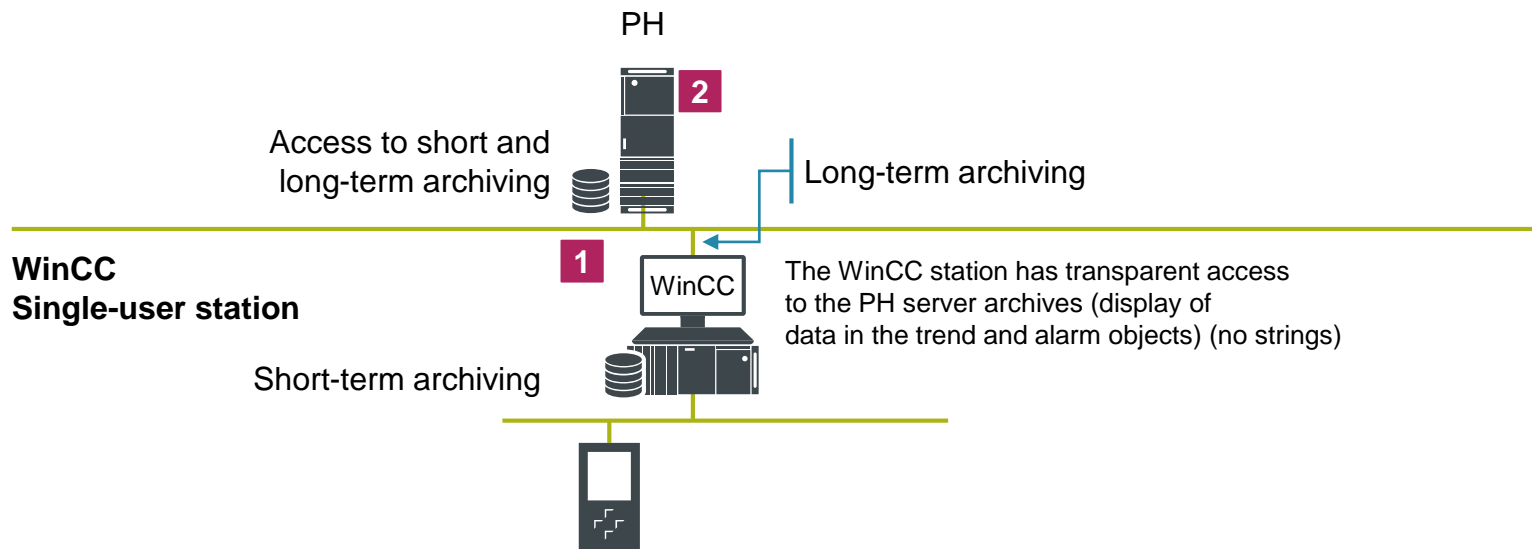

1 WinCC V7.5 SP1 basic package

WinCC V7.5 SP1 RT n
SIMATIC Net V16

2 SIMATIC ProcessHistorian 2014 SP3 upd4

MLFB: 6AV6361-1AA01-4AA0

Operating system, MS SQL Server

- Windows Server 2008 R2 SP1 64 Bit Standard/Enterprise
- Windows Server 2012 R2 /2016 64 Bit Standard/Enterprise

Additional Information

Process Historian is installed only on one OS Server 2008 R2 SP1 or 2012 R2 /2016 .
WinCC is not required (and must not be installed) on a PH server.
The Alarm Logging and Tag Logging archives are transferred to the PH server in real time with a secure connection. If the communication is interrupted, the data is buffered on the WinCC computer (Store & Forward Cache)

Archive server (SIMATIC ProcessHistorian) – Centralized data archiving

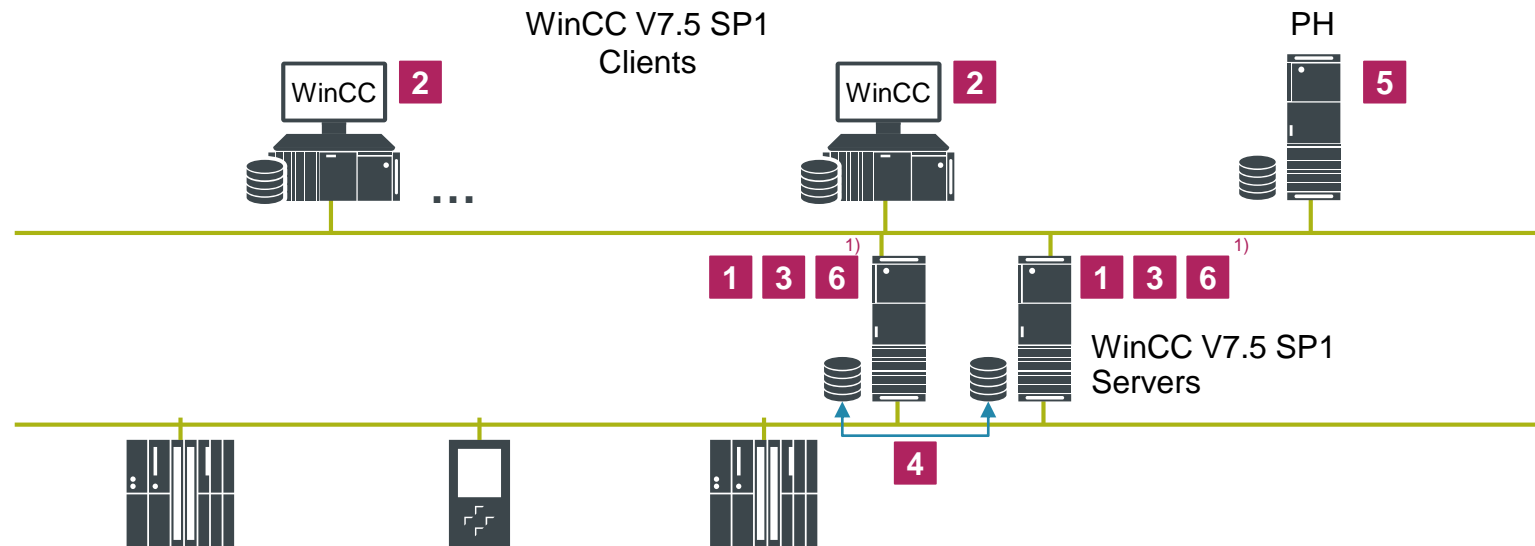

Additional Information

All archive tags and the messages of all servers are stored centrally on the PH server. The administration and configuration of the data is still carried out in WinCC, so a configuration in the PH is not necessary again. The clients transparently access the data of the servers and the PH server.

1) There is no archive license on the PH server. If required, the archive licenses are located on the affected servers and / or single-user computers

1 WinCC V7.5 SP1 basic package

WinCC V7.5 SP1 RT n
SIMATIC Net V16

2 WinCC Client

MLFB: 6AV6381-2CA07-5AX0

3 WinCC Server

MLFB: 6AV6371-1CA07-5AX0

4 WinCC Redundancy

MLFB: 6AV6371-1CF07-5AX0

5 ProcessHistorian 2014 SP3 upd4 Basic Package

MLFB: 6AV6361-1AA01-4AA0

6 WinCC Tag Logging – Optionally with > 512 archives

Z. B.: for 5000 Archiv tags
MLFB: 6AV6371-1DQ17-5BX0

SIMATIC ProcessHistorian – Redundancy – High availability archiving

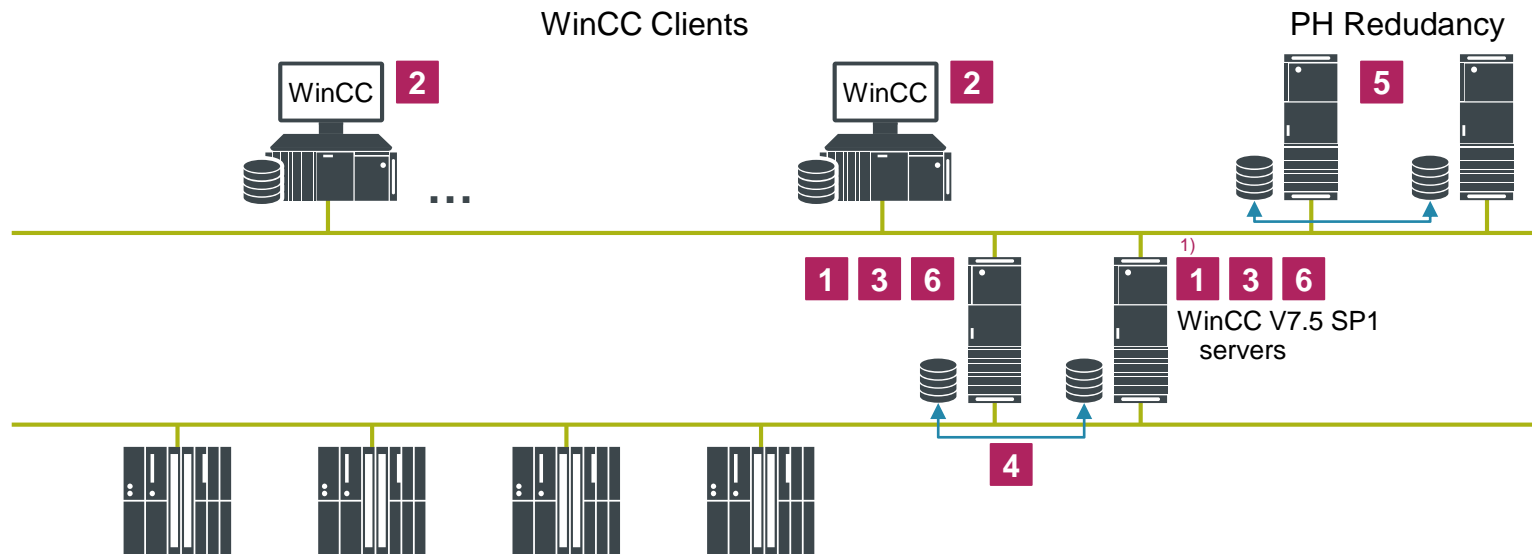

1	WinCC V7.5 SP1 RT Basic
	WinCC V7.5 SP1 RT n SIMATIC Net V16
2	WinCC Client
	MLFB: 6AV6381-2CA07-5AX0
3	WinCC Server
	MLFB: 6AV6371-1CA07-5AX0
4	WinCC Redundancy
	MLFB: 6AV6371-1CF07-5AX0
5	Process Historian 2014 SP3 upd4 – Redundancy Complete
	MLFB: 6AV6361-1AA01-4AA0
6	WinCC Tag Logging – optional if > 512 archives
	E.g.: For 5,000 archive variables MLFB: 6AV6371-1DQ17-4BX0

Additional Information

PH redundancy is based on SQL server replication mechanisms.

Reminder: Switch-over to PH redundancy if a PH Single server is already present can be done with

- a new PH single license
- a PH Redundancy license (6AV6361-1BA01-4AA0)

SIMATIC Information Server – Web Reporting System

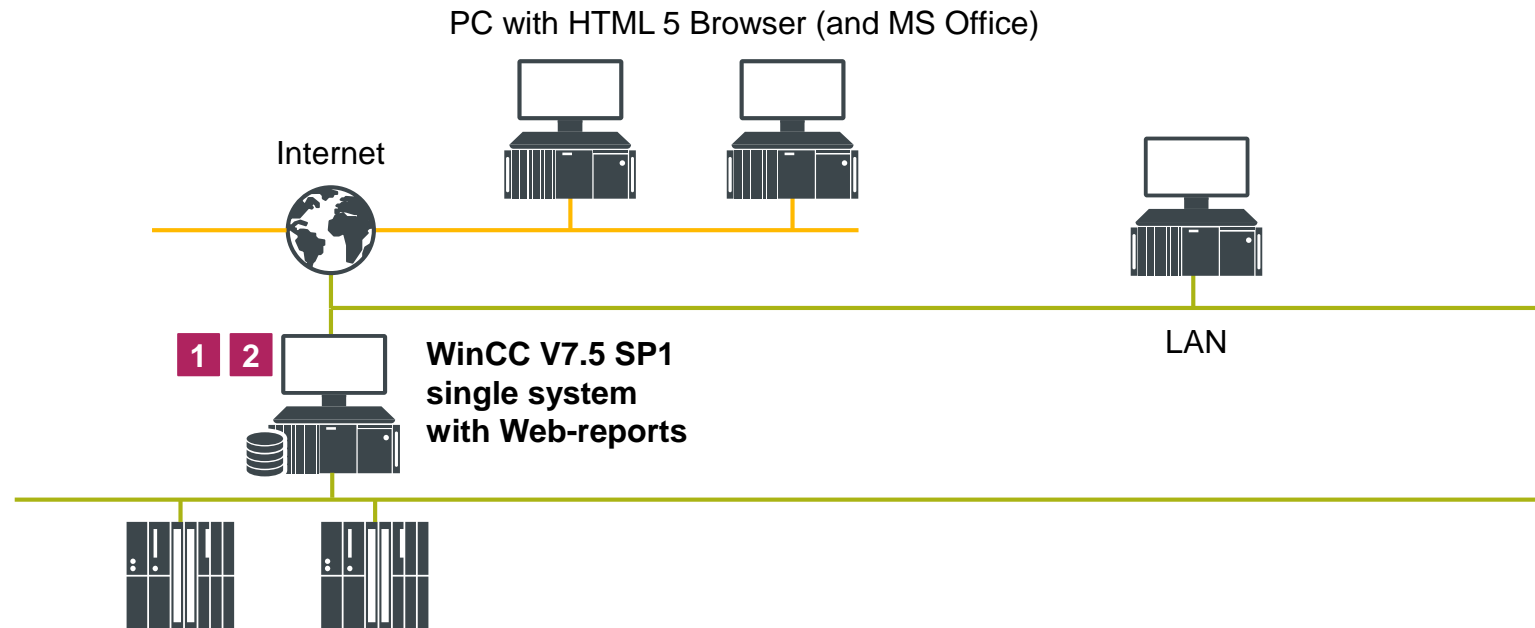

Additional Information

IS and DataMonitor can be installed and used on the same computer.

Standard- and user-specific reports (with report builder of MS SQL reporting services)
Transparent accesses on WinCC Archive in excel and word (2007, 2010, 2013 and 2016)

1 WinCC V7.5 SP1 Basic

WinCC V7.5 SP1 RT n
SIMATIC Net V16

2 SIMATIC Information Server 2014 SP3 upd4
Basic package

MLFB: 6AV6361-2AA01-4AH0

The basic package includes:

- 1x data source access
(connection with a WinCC-database)
- 3x client access
(three client-accesses at the same time)

SIMATIC Information Server – Web Reporting System

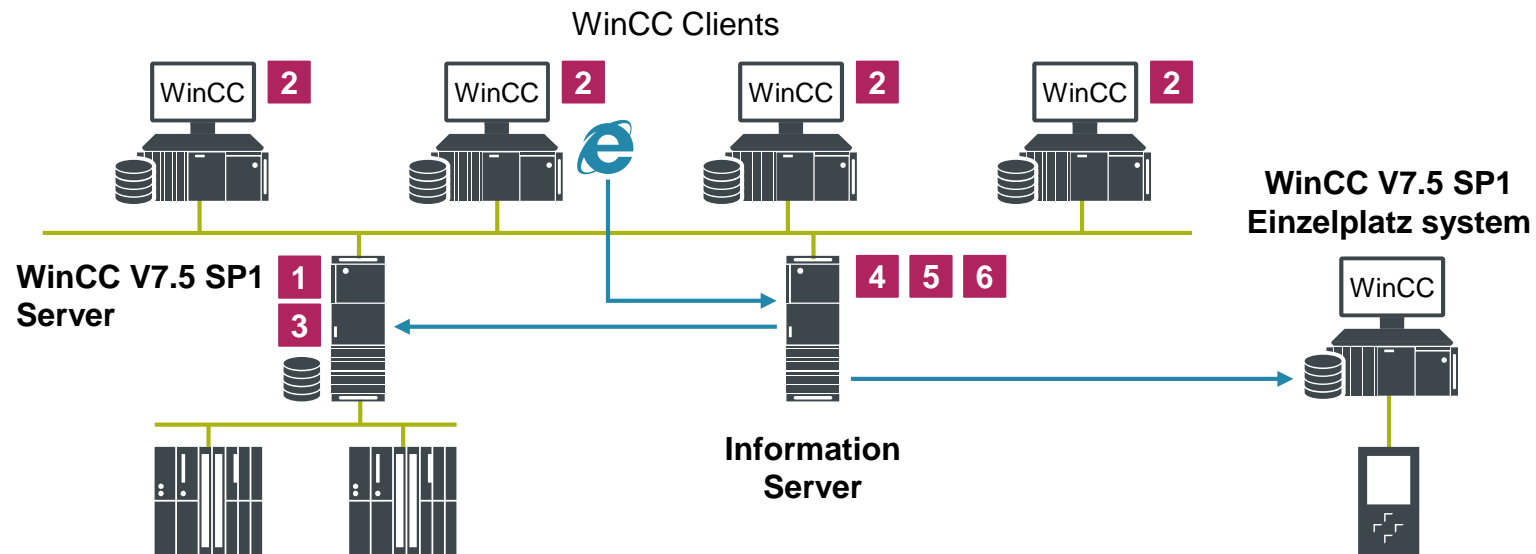

Additional Information

The client access- and data source access-licenses are required parallel.
In our example there are max. four clients simultaneously and two WinCC-data sources.

1	WinCC V7.5 SP1 basic package
WinCC V7.5 SP1 RT n SIMATIC Net V16	
2	WinCC Client
MLFB: 6AV6381-2CA07-5AX0	
3	WinCC Server
MLFB: 6AV6371-1CA07-5AX0	
4	WinCC IS 2014 SP3 upd4 basic package (enthält 3 Client-Access Lizenzen)
MLFB: 6AV6361-2AA01-4AH0	
5	WinCC IS Client Access (1)
MLFB: 6AV6361-2BD00-0AJ0	
6	WinCC IS Datasource Access (2)
MLFB: 2 x 6AV6361-2CD00-0AJ0	

Analyse + Reporting with PM-ANALYZE installation variants

* The installation on a separate server requires a Microsoft SQL Server 2008, 2014, 2016 (32/64)

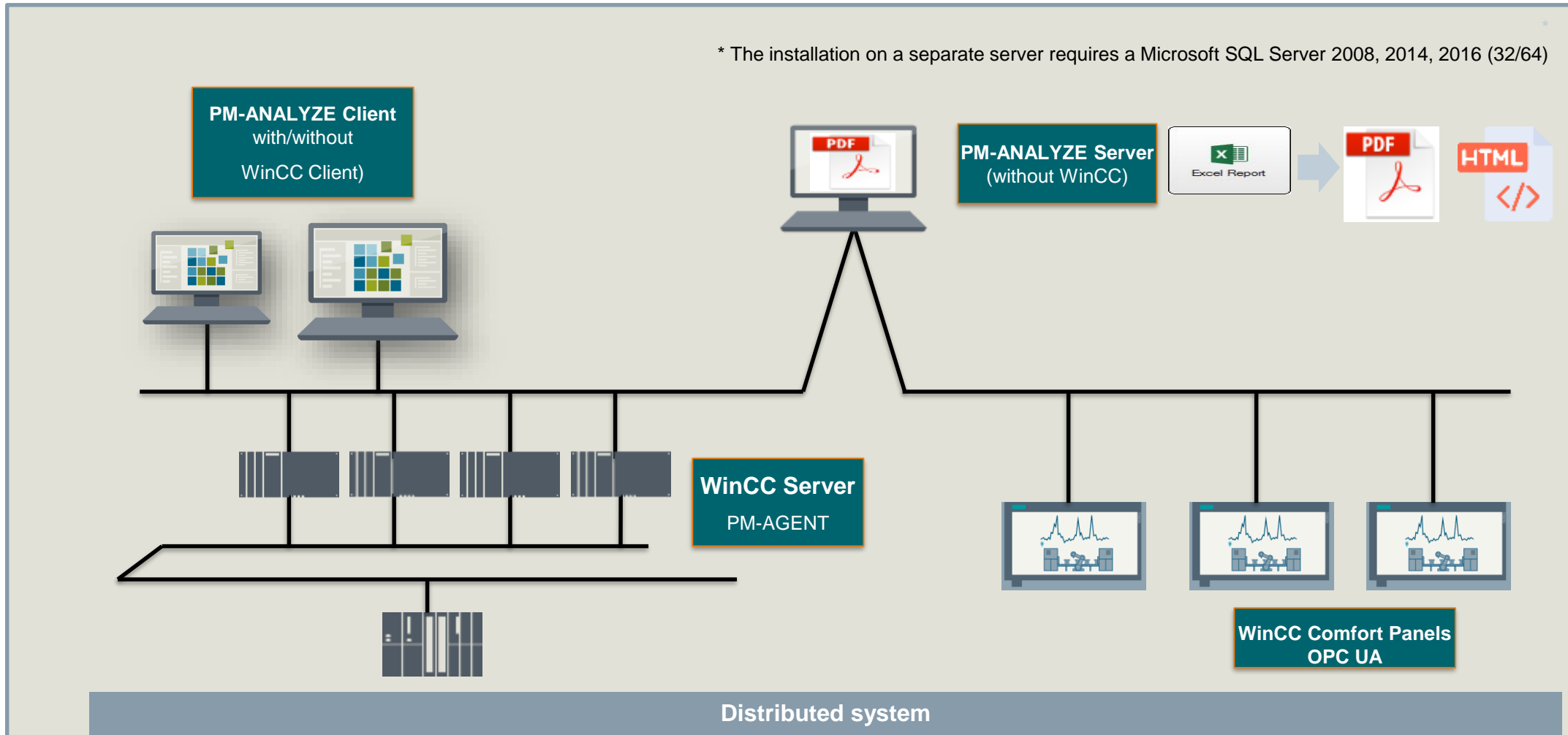

Single-user station Web server – Remote monitoring/operation stations and display and analysis for Web client

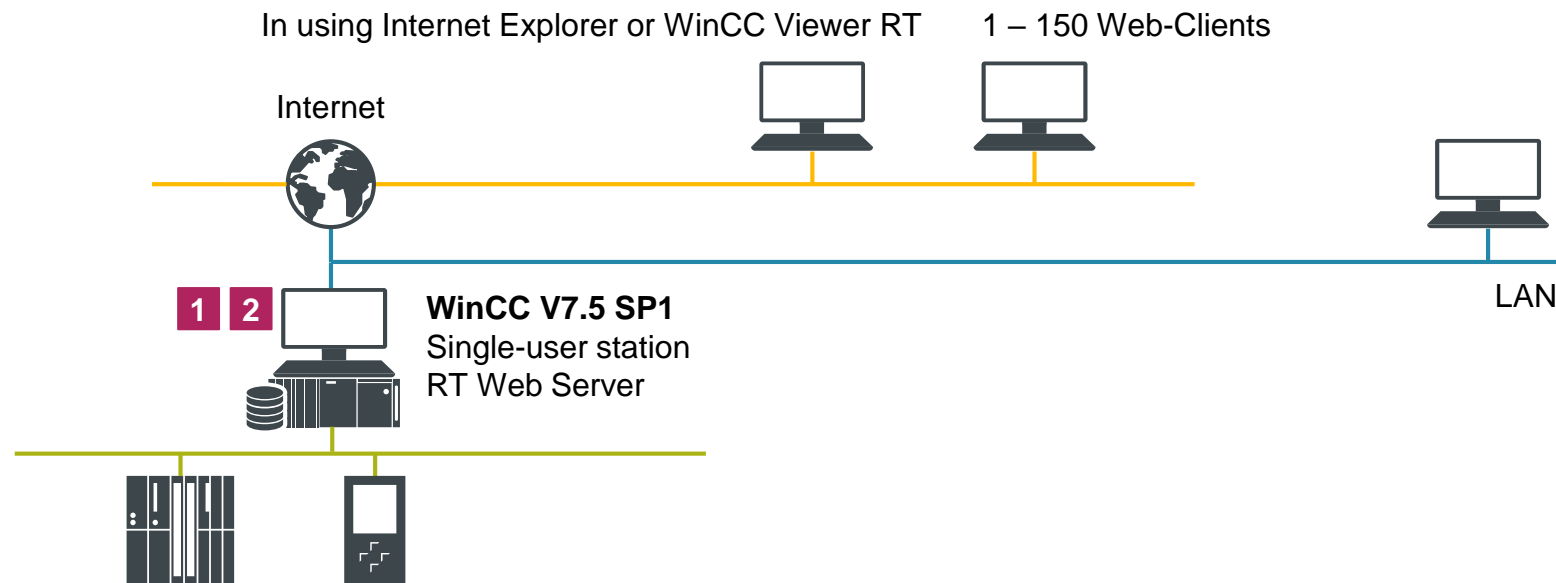

1	WinCC V7.5 SP1 Basic
WinCC V7.5 SP1 RT n SIMATIC Net V16	
2	WinCC WebNavigator
E.g.: For 3 Clients MLFB: 6AV6362-1AD00-0BB0	
and/or	
2	WinCC DataMonitor
E.g.: For 1 Clients MLFB:6AV6362-3AD00-0BB0	

Additional Information

WinCC/WebNavigator allows remote PC-stations to behave as **monitoring/operating stations** via a local Intranet or via the Internet.

WinCC/DataMonitor serves to evaluate the real-time data, archives or alarms of the process and to Distribute them via an Intranet or Internet in **Display mode only!**

In all cases, a Web license for n Clients allows n clients to log in at the same time to the WinCC Web server

Single-user station Web server – A particular case for 1 Web connection (WebNavigator diagnostics)

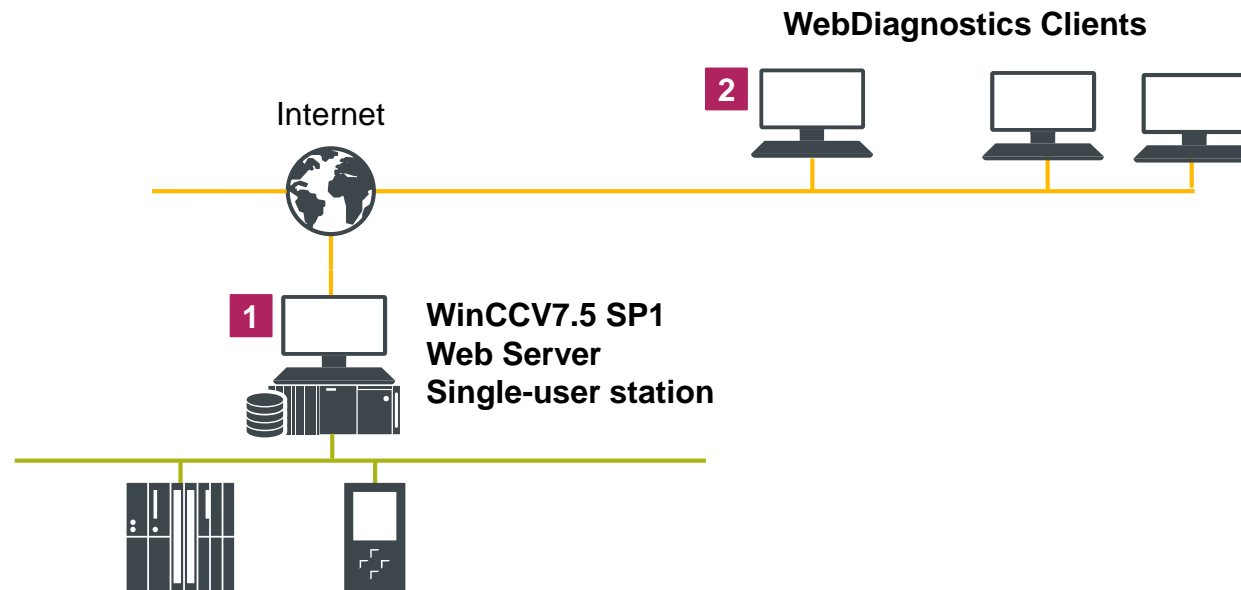

1 WinCC V7.5 SP1 Basic

WinCC V7.5 SP1 RT n
SIMATIC Net V16

2 WinCC WebDiagnostics Client

MLFB: 6AV6362-1BA00-0BB0

Additional Information

In contrast to the preceding case, a token is assigned to a Web client station and only that station will be able to connect to the Web server (always via Intranet or Internet)

An additional diagnostic server license on the WebNavigator server is no longer necessary.

Single-user station Web server – Combination of WebNavigator and Diagnostic Client licenses

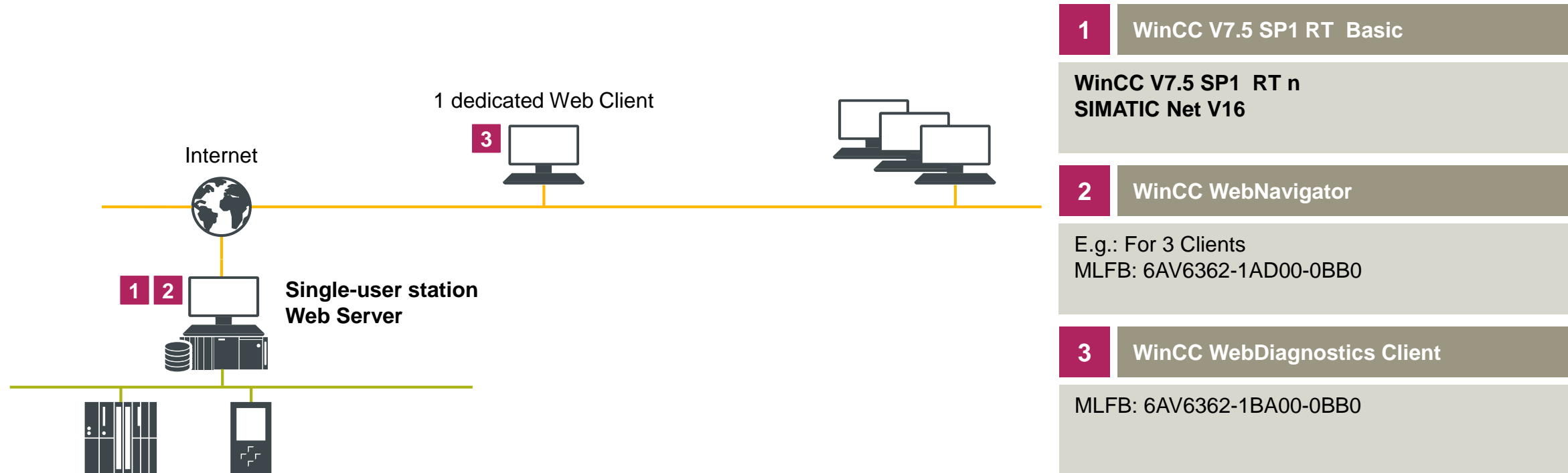

Additional Information

In the case of 4 connections: It is possible to use a 3-connections package that allows for the connection of 3 standard clients with the addition of a 4th dedicated client with this Diagnostics license

Web-Solution 1: Web Solution based on (RDP-Clients) on Industrial ThinClient V3 / Thin Client V3 PRO

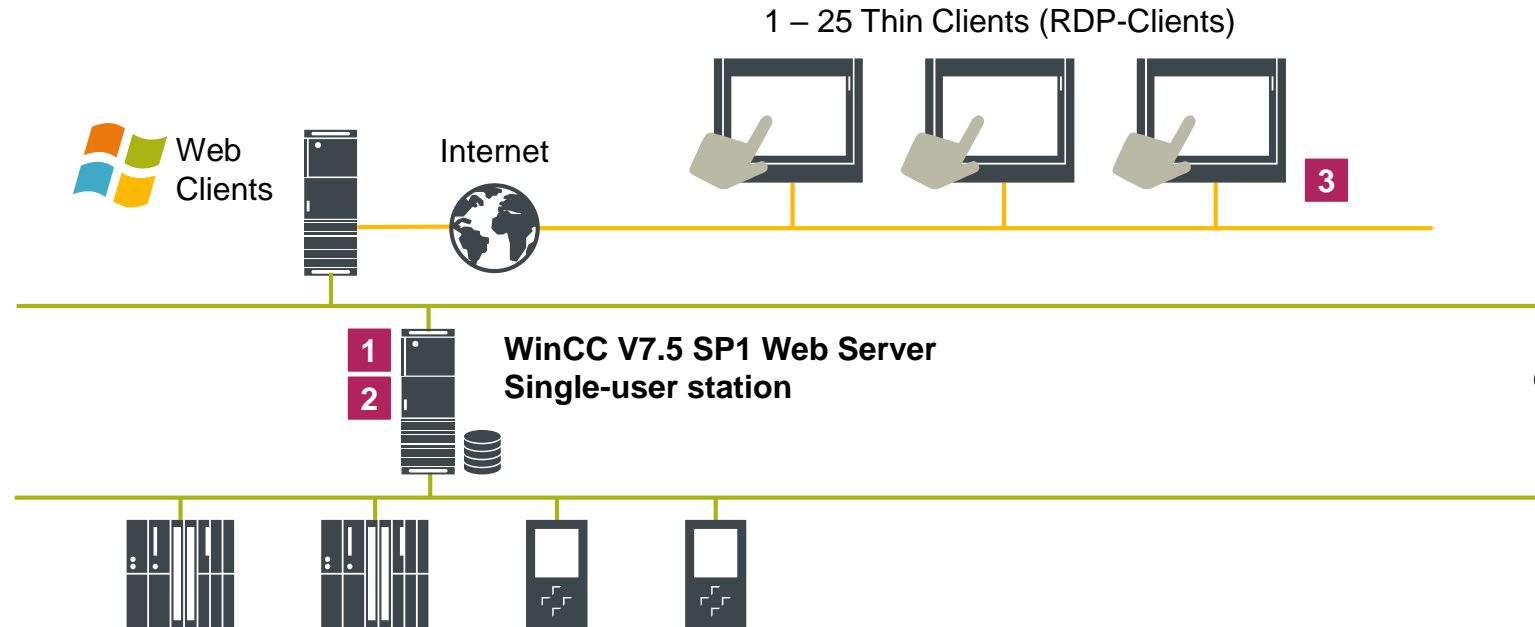

By using the services of the Windows Server Terminal, it is possible to use the functions of the WebNavigator or DataMonitor for thin Clients (low resources and operating system not supported by WinCC) e.g.: SIMATIC webpanel (customiced Thin Client)

1 WinCC V7.5 SP1 basic package

WinCC V7.5 SP1 RT n
SIMATIC Net V16

2 WinCC WebNavigator

Z.B.: für 10 Clients
MLFB: 6AV6362-1AF00-0BB0

Or

2 WinCC DataMonitor

Z.B.: Für 10 Clients
MLFB: 6AV6362-3AF00-0BB0

3 Thin Client V3 / Thin Client V3 PRO

6AV6646-1BA15-0AA0 SIMATIC ITC1500 V3
6AV6646-1BA15-0NA0 SIMATIC ITC1500 V3
6AV6646-1BA18-0AA0 SIMATIC ITC1900 V3
6AV6646-1BA18-0NA0 SIMATIC ITC1900 V3
6AV6646-1BA22-1AA0 SIMATIC ITC2200 V3
6AV6646-1BA22-1NA0 SIMATIC ITC2200 V3

Web Solution 2: Operator control and monitoring of WinCC systems with HTML 5 browser (Tablet / PC / WebPanel)

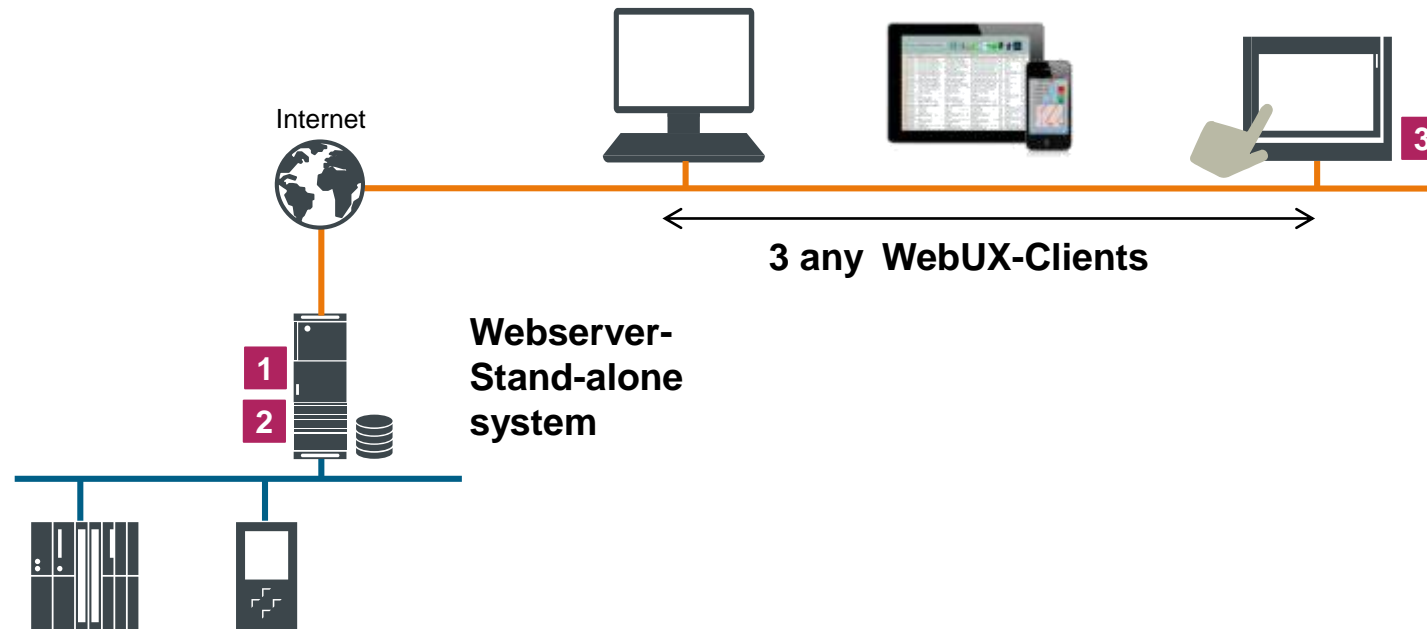

Additional Information

WebPanel IWP (Linux based software)

Integrated current **Chromium Browser v66** (perfect for WebUX)

The IWP software supports different hardware architect (Basic Panels / ITC /IPC)

1 WinCC V7.5 SP1 Basispaket

WinCC V7.5 SP1 RT n
SIMATIC Net V16

2 WinCC WebUX

z. B.: WebUX Operate 3 Clients
MLFB: 6AV6362-2BD00-0BB

3 WebPanel (IWP)

Attention:
Standard ThinClient V3 uses a Mozilla Firefox browser that is not optimal for WebUX

Please order the new WebPanel based on Thin Client V3 with the new Google Chrome browser

*) WebPanel (IWP) available from Q1/2020

Virtualization for the clients and/or WinCC Servers

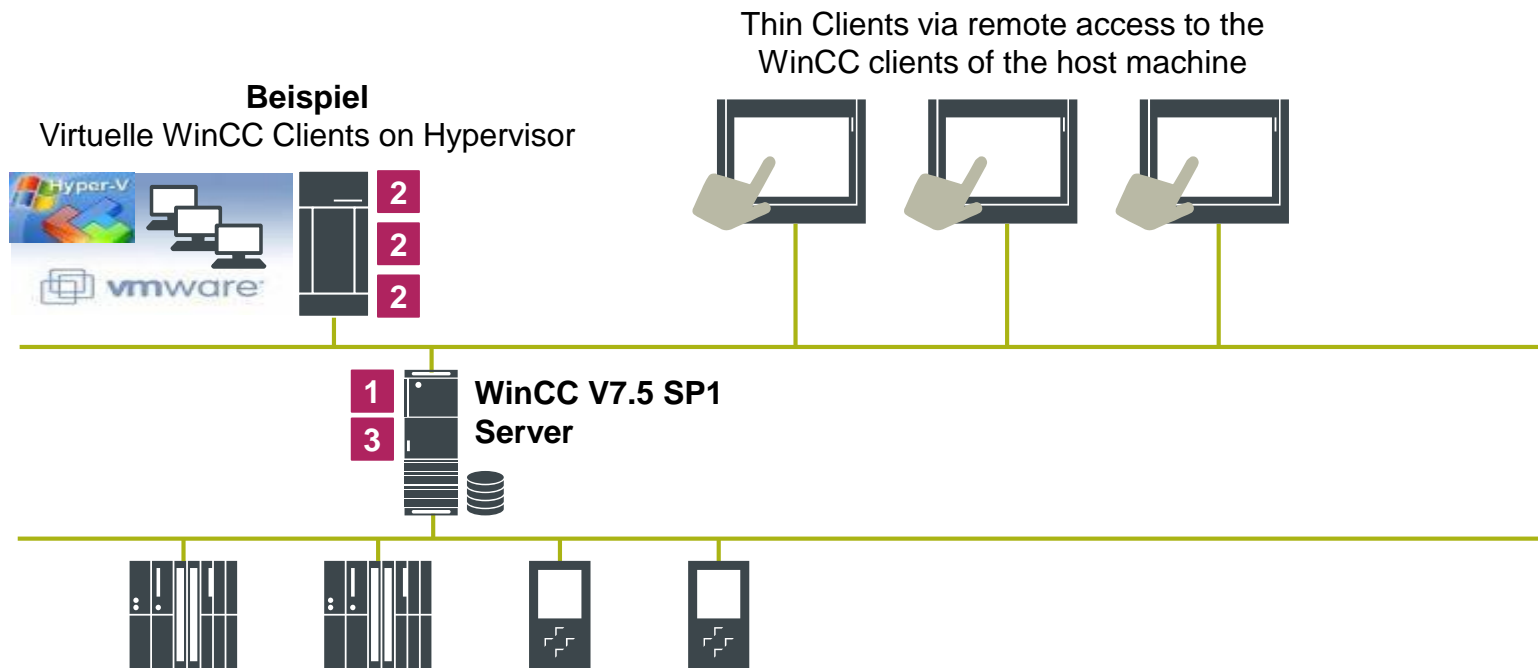

1 WinCC V7.5 SP1 basic package

WinCC V7.5 SP1 RT n
SIMATIC Net V16

2 WinCC Client

MLFB: 6AV6381-2CA07-5AX0

3 WinCC Server

MLFB: 6AV6371-1CA07-5AX0

WinCC clients run with the hypervisor system.
 That WinCC systems run like a normal application in virtual machines.
 WinCC itself can not be a virtual system on a hypervisor, but always requires a Windows VM.
 WinCC servers can also be operated with the hypervisor system.
 The number of WinCC clients / servers depends on the physical resources of the host computer

WinCC V7.5 SP1 User archiv – User data management

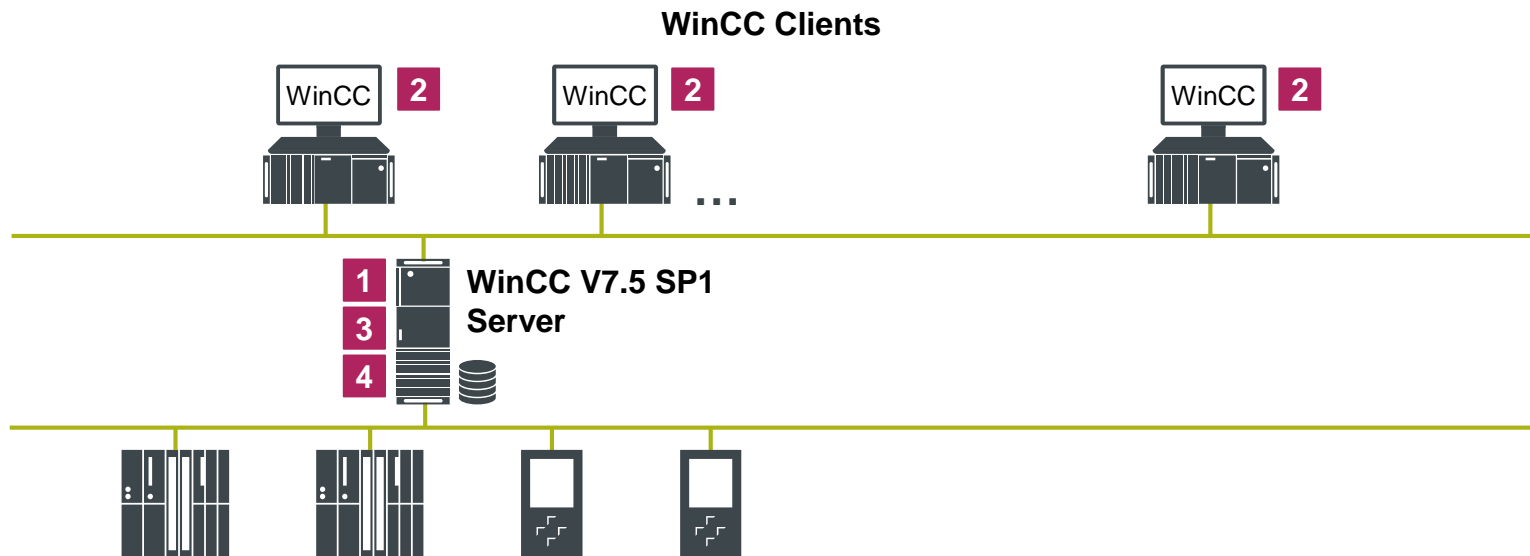

WinCC user archive allows a user to manage his archives in the form of tables;
E.g.: Management of recipes – management of batch parameters, etc.
The user archive license is on the server.
The user archive component is installed for each Client but no user archive license
is required for these customers.

1 WinCC V7.5 SP1 RT Basic

WinCC V7.5 SP1 RT client
SIMATIC Net V16

2 WinCC Client

MLFB: 6AV6381-2CA07-5AX0

3 WinCC Server

MLFB: 6AV6371-1CA07-5AX0

4 WinCC Userarchiv

MLFB: 6AV6371-1CB07-5AX0

WinCC Archive – archive tags

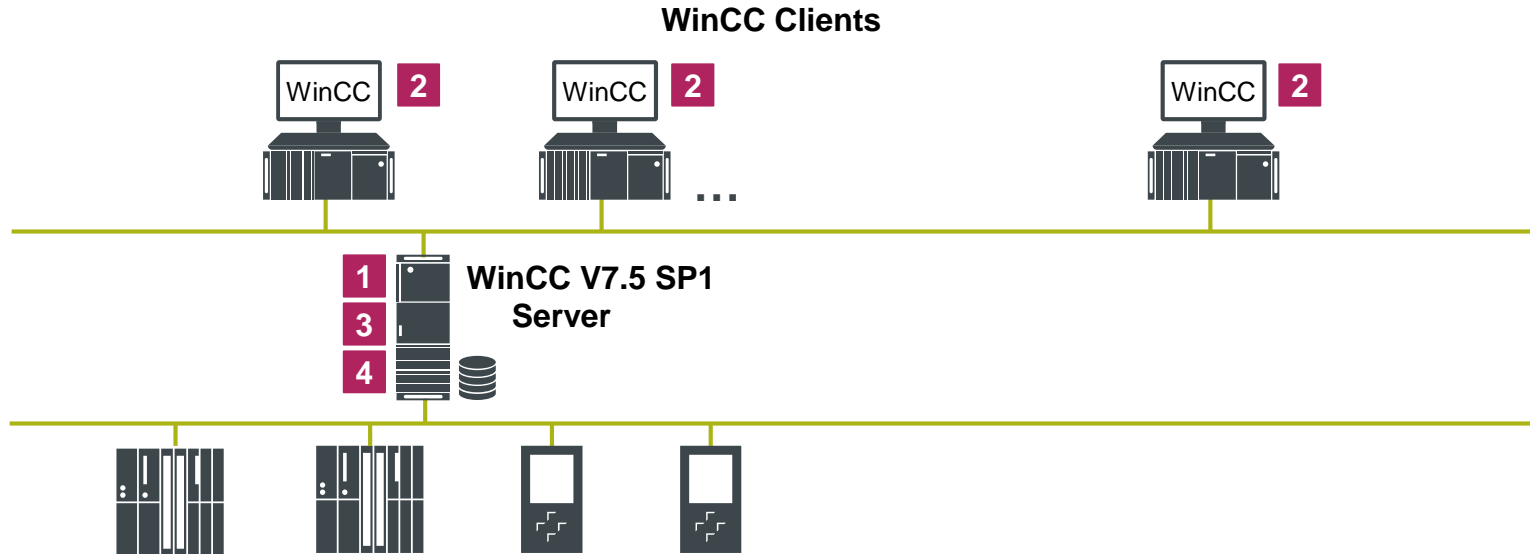

1	WinCC Runtime
WinCC V7.5 SP1 RT n	
2	WinCC Client
MLFB: 6AV6381-2CA07-5AX0	
3	WinCC Server
MLFB: 6AV6371-1CA07-5AX0	
4	WinCC Archive
Z.B.: 1500 archive variables MLFB: 6AV6371-1DQ17-5AX0 Z.B.: 5000 archive variables MLFB: 6AV6371-1DQ17-5BX0	

With WinCC archive, the number of archive tags can be increased.
 The base license is valid for 512 archive tags.
 The archive license is located on the server.
 Licenses are countable (which become 512 archive variables of the base package not added to the 5000 archive tag package)
 You can increase the number of archive tags that need to be licensed by combining several packages

Functional differences of WinCC RT Professional V16 und WinCC 7.5 SP1



Functions	WinCC RT Professional V16	WinCC V7.5 SP1
PowerTags	ES: 512, 4k, max. RT: 128, 512, 2k, 4k, 8k, 64k1,, 100K, 150K, 265k	RC: 128, 512, 2k, 8k, 64k, 100K, 150K, 256k RT: 128, 512, 2k, 8k, 64k, 100K, 150K, 265k
Screens / screen objects	No limit / no limit	No limit / no limit
Alarms	150,000	150,000
	256 alarm classes, 32 types in groups, 17 alarm priorities	256 alarm classes 17 alarm priorities (0 to 16)
Server/client	1 server / 32 clients	18 servers / 64 clients 50 multi-clients
Trends *) 500/ 512 archive tags incl.	max. 80,000 (server)	max. 80,000 (server)
Recipes **)	Recipes: No limit / Elements per recipe: 500 / 1 000000 fields Records per archive: 10 000	Recipes: No limit / Elements per recipe: 500 / 1 000000 fields Records per archive: 10 000
WebNavigator WebUX	max.150 clients max.100 clients	max.150 clients max.100 clients
PLC connections	Up to 128 connections, -max. 128 x S7-1200 / S7-1500 Connections -max. 64 x S7-300 / 400 Connections	128 x S7-1500/ 32 x S7-1200 / 64 x S7-300/400

*) V7.x: Archive tags Max. 80,000 tags (32-bit OS) / 260,000 tags (64-bit OS) in a project (incl. logging tags)

**) V7.x: UserArchives Max. 320,000/640,000 screen objects in a project (32-bit OS/64-bit OS)

Functional differences of WinCC RT Professional V16 und WinCC 7.5 SP1

Communication	WinCC Professional V16	WinCC V7.5 SP1
MPI / PROFIBUS	Yes	Yes
OPC UA	OPC UA Server : DA, HAD, A&C (Alarm & Condition)	UA Server: DA, HAD, A&C (Alarm & Condition)
	UA Client (DA)	UA Client (DA / A&C)
SIMOTION	Via OPC UA	Yes
SINUMERIK	NO	Add-on
Allen Bradley	Ethernet/IP	Ethernet/IP
Modicon	Modbus (TCP)	Modbus (TCP)
Mitsubishi	MC TCP/IP	i-QR PLCs
IEC Client	NO	IEC 61850 (Add-on)
DNP3	NO	Option Telecontrol
MQTT	NO	WinCC Cloud Connect

SIMATIC IPC and SIMATIC Software

+Best State of the art technology



+SIMATIC WinCC Software



Packages

Available for all SIMATIC IPCs that meet the SCADA requirements

2 x order numbers:







- 1 x for the IPC and
- 1 x for the software

Price advantage **with simultaneous ordering** of the - SIMATIC IPC and the WinCC software

description	Order number
WinCC-IPC-Package V7.5 SP1, RT Client	6AV6382-2AA07-5AX0
WinCC-IPC-Package V7.5 SP1, RT 128	6AV6382-2CA07-5AX0
WinCC-IPC-Package V7.5 SP1, RT 512	6AV6382-2DA07-5AX0
WinCC-IPC-Package V7.5 SP1, RT 2048	6AV6382-2EA07-5AX0
WinCC-IPC-Package V7.5 SP1, RT 8192	6AV6382-2HA07-5AX0
WinCC-IPC-Package V7.5 SP1, RT65536	6AV6382-2FA07-5AX0

description	Order number
WinCC-IPC-Package V7.5 SP1, ASIA , RT Client	6AV6382-2AA07-5AV0
WinCC-IPC-Package V7.5 SP1, ASIA , RT 128	6AV6382-2CA07-5AV0
WinCC-IPC-Package V7.5 SP1, ASIA , RT 512	6AV6382-2DA07-5AV0
WinCC-IPC-Package V7.5 SP1, ASIA , RT2048	6AV6382-2EA07-5AV0
WinCC-IPC-Package V7.5 SP1, ASIA , RT8192	6AV6382-2HA07-5AV0
WinCC-IPC-Package V7.5 SP1, ASIA , RT65536	6AV6382-2FA07-5AV0

Promoters Selection Guide – Software packages for SIMATIC IPCs

	WinCC flexible RT	WinCC RT Advanced	WinCC RT Professional	WinCC V7.x
2x7D/E 	✓	✓	client ✓	client ✓
4x7D 	✓	✓	✓	✓
6x7 / 8x7 C 	✓	✓	✓	✓
647 / 847 C/D 	✓	✓	✓	✓
547E/G 	✓	✓	✓	✓
347E 	✓	✓	✓	✓

Promoters Selection Guide – Software packages for SIMATIC IPCs

[Additional
information](#)

SIEMENS
Ingenuity for life

	WinCC flexible RT	WinCC RT Advanced	WinCC RT Professional	WinCC V7.x
2x7E 	✓	✓	client ✓	client ✓
377E 	✓	✓	client ✓	client ✓
ITP1000 	✓	✓	✓	✓
647 / 847E 				
127E 	✓	✓	✓	✓

Only for german SCADA SSP

[www004.siemens.net/bu01\\$\NbgM\PROJ\PROMOTOREN_VM\VM_Ware\2019_10_Image_IP127E_Wind10WinCCV75_upd4](http://www004.siemens.net/bu01$\NbgM\PROJ\PROMOTOREN_VM\VM_Ware\2019_10_Image_IP127E_Wind10WinCCV75_upd4)

unrestricted © Siemens 2019

Thank you for your attention!



Subject to changes and errors. The information given in this document only contains general descriptions and/or performance features which may not always specifically reflect those described, or which may undergo modification in the course of further development of the products. The requested performance features are binding only when they are expressly agreed upon in the concluded contract.

All product designations, product names, etc. may contain trademarks or other rights of Siemens, its affiliated companies or third parties.

Their unauthorized use may infringe the rights of the respective owner.

[siemens.de/wincc-v7](https://www.siemens.de/wincc-v7)